

## Chip Infrared LED With Right Angle Lens

### SIR12-21C/TR8

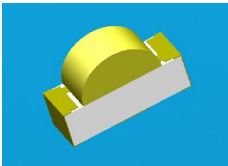

#### Features

- Small double-end package
- Low forward voltage
- Good spectral matching to Si photo detector
- Package in 8mm tape on 7" diameter reel
- Pb free
- The product itself will remain within RoHS compliant version.

#### Descriptions

SIR12-21C/TR8 is an infrared emitting diode in miniature SMD package molded in a water clear plastic with right angle lens.

The device is spectrally matched with silicon photodiode and phototransistor.

#### Applications

- Household Appliances
- Electric Appliances
- Smoke detector
- Floppy disk drive

#### Device Selection Guide

Part Category	Chip Material	Lens Color
SIR	GaAlAs	Water clear

Package Dimensions

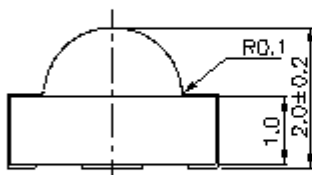
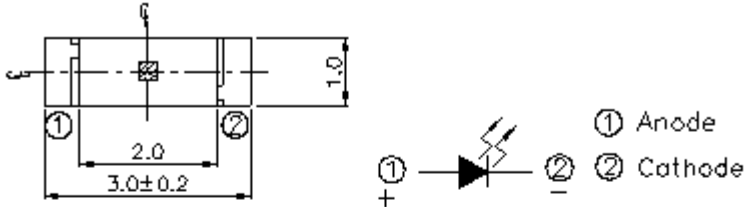

For reflow soldering (propose)

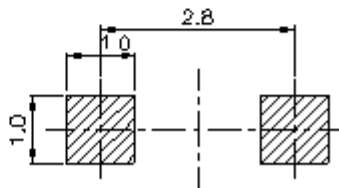
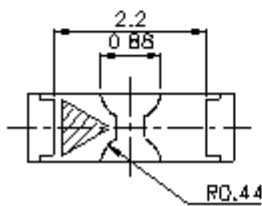

- Notes:** 1.All dimensions are in millimeters  
 2.Tolerances unless dimensions  $\pm 0.1\text{mm}$

**Absolute Maximum Ratings (Ta=25 )**

Parameter	Symbol	Rating	Units
Continuous Forward Current	$I_F$	65	mA
Reverse Voltage	$V_R$	5	V
Operating Temperature	$T_{opr}$	-25 ~ +85	
Storage Temperature	$T_{stg}$	-40 ~ +85	
Soldering Temperature *1	$T_{sol}$	260	
Power Dissipation at(or below) 25 Free Air Temperature	$P_d$	110	mW

**Notes:** \*1. Soldering time 5 seconds.

**Electro-Optical Characteristics (Ta=25 )**

Parameter	Symbol	Condition	Min.	Typ.	Max.	Units
Radiant Intensity	I <sub>e</sub>	I <sub>F</sub> =20mA	0.5	0.9	--	mW /sr
Peak Wavelength	λ	I <sub>F</sub> =20mA	--	875	--	nm
Spectral Bandwidth		I <sub>F</sub> =20mA	--	80	--	nm
Forward Voltage	V <sub>F</sub>	I <sub>F</sub> =20mA	--	1.3	1.6	V
Reverse Current	I <sub>R</sub>	V <sub>R</sub> =5V	--	--	10	μ A
View Angle	2 1/2	I <sub>F</sub> =20mA	--	160	--	deg

EVERLIGHT

Typical Electro-Optical Characteristics Curves

Fig.1 Forward Current vs. Ambient Temperature

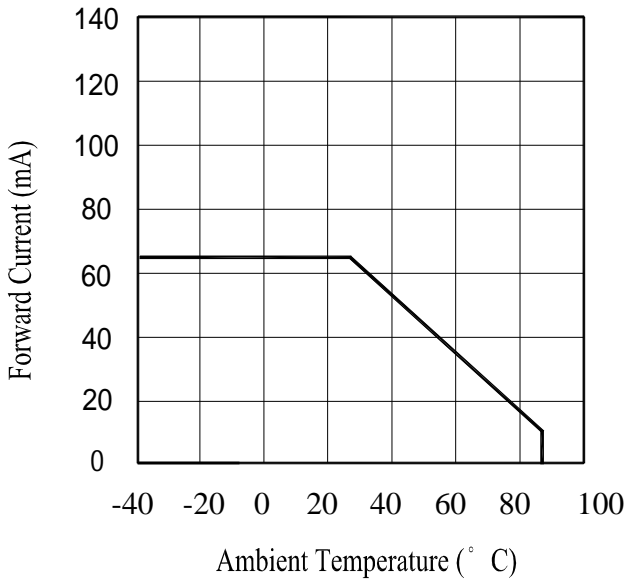

Fig.2 Spectral Distribution

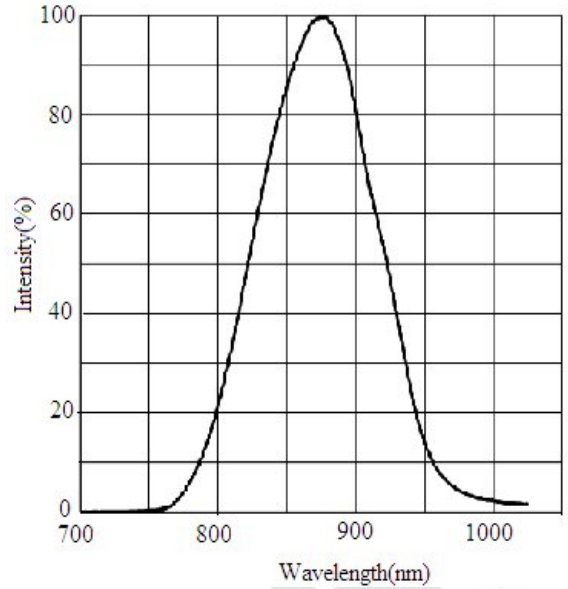

Fig.3 Forward Current vs. Forward Voltage

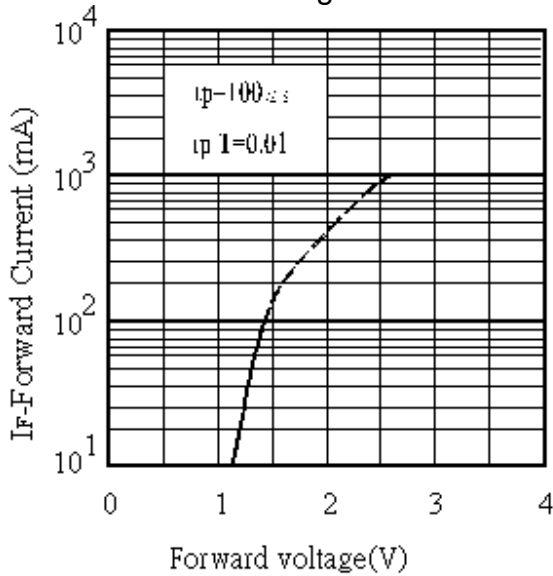
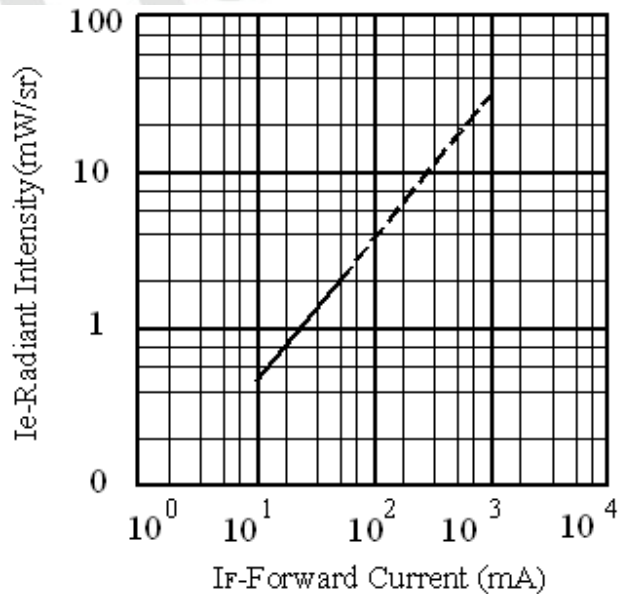
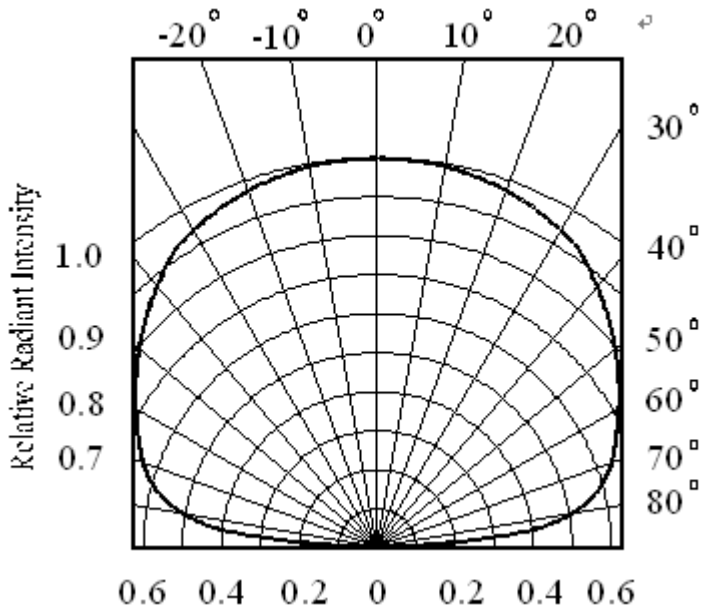

Fig.4 Relative Intensity vs. Forward Current



### Typical Electro-Optical Characteristics Curves

Fig.5 Relative Radiant Intensity vs.  
Angular Displacement



## Precautions For Use

### 1. Over-current-proof

Customer must apply resistors for protection , otherwise slight voltage shift will cause big current change ( Burn out will happen ).

### 2. Storage

2.1 Do not open moisture proof bag before the products are ready to use.

2.2 Before opening the package, the LEDs should be kept at 30 °C or less and 90%RH or less.

2.3 The LEDs should be used within a year.

2.4 After opening the package, the LEDs should be kept at 30 °C or less and 60%RH or less.

2.5 The LEDs should be used within 168 hours (7 days) after opening the package.

2.6 If the moisture absorbent material (silica gel) has faded away or the LEDs have exceeded the storage time, baking treatment should be performed using the following conditions.

Baking treatment :  $60\pm 5$  °C for 24 hours.

### 3. Soldering Condition

#### 3.1 Pb-free solder temperature profile

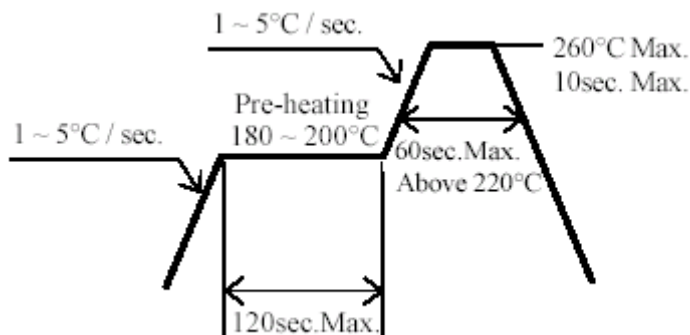

3.2 Reflow soldering should not be done more than two times.

3.3 When soldering, do not put stress on the LEDs during heating.

3.4 After soldering, do not warp the circuit board.

#### 4.Soldering Iron

Each terminal is to go to the tip of soldering iron temperature less than 350 for 3 seconds within once in less than the soldering iron capacity 25W. Leave two seconds and more intervals, and do soldering of each terminal. Be careful because the damage of the product is often started at the time of the hand solder.

#### 5.Repairing

Repair should not be done after the LEDs have been soldered. When repairing is unavoidable, a double-head soldering iron should be used (as below figure). It should be confirmed beforehand whether the characteristics of the LEDs will or will not be damaged by repairing.

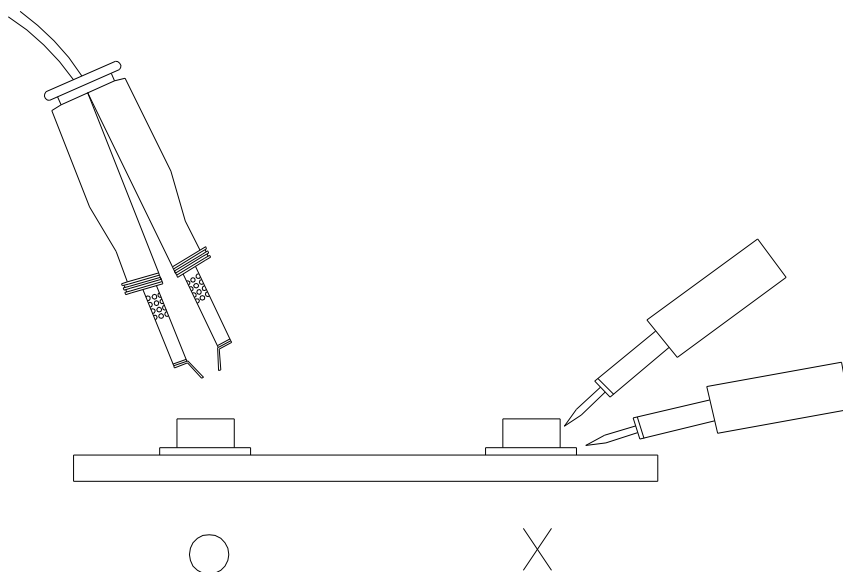

Package Dimensions

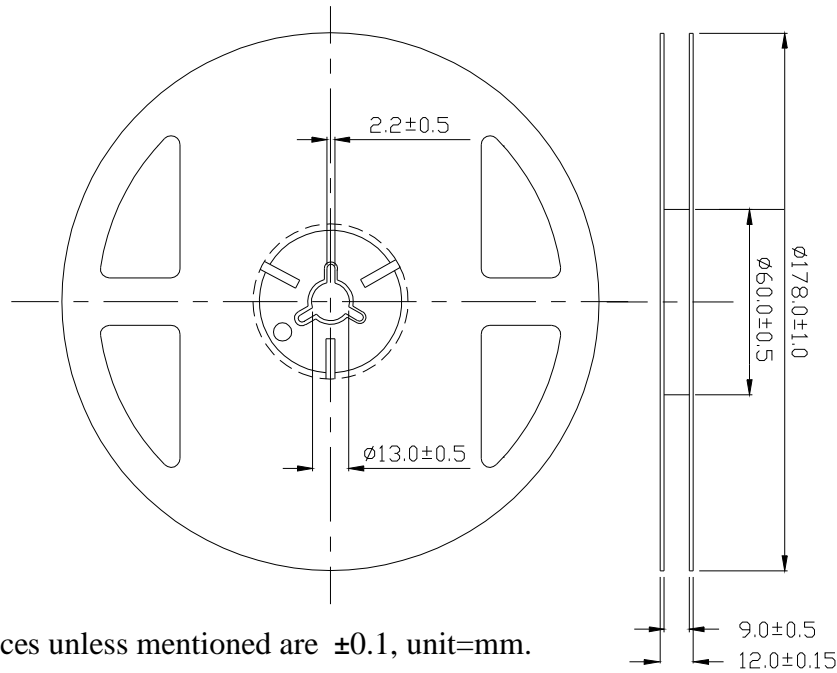

Note: The tolerances unless mentioned are  $\pm 0.1$ , unit=mm.

Carrier Taping Dimensions: (Quantity: 2000PCS/Reel)

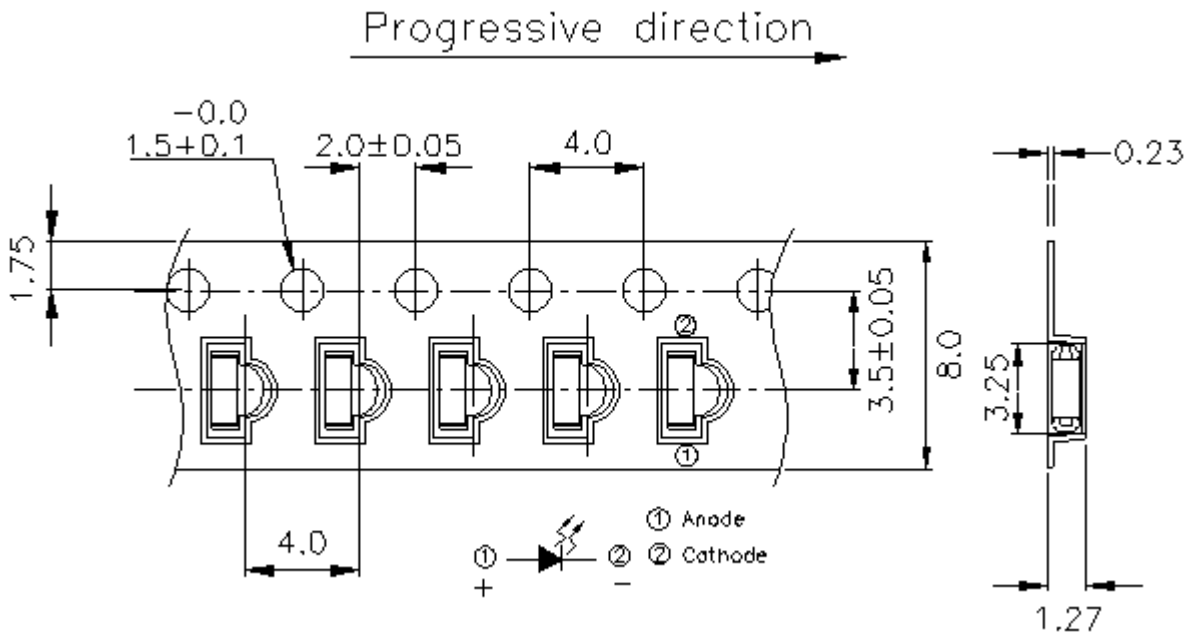

Note: The tolerances unless mentioned are  $\pm 0.1$ , unit=mm



### Label Form Specification



CPN: Customer's Production Number

P/N: Production Number<sup>+</sup>

QTY: Packing Quantity<sup>+</sup>

CAT: Ranks<sup>+</sup>

HUE: Peak Wavelength<sup>+</sup>

REF: Reference<sup>+</sup>

LOT No: Lot Number<sup>+</sup>

### Notes

1. Above specification may be changed without notice. EVERLIGHT will reserve authority on material change for above specification.
2. When using this product, please observe the absolute maximum ratings and the instructions for using outlined in these specification sheets. EVERLIGHT assumes no responsibility for any damage resulting from use of the product which does not comply with the absolute maximum ratings and the instructions included in these specification sheets.
3. These specification sheets include materials protected under copyright of EVERLIGHT corporation. Please don't reproduce or cause anyone to reproduce them without EVERLIGHT's consent.

**EVERLIGHT ELECTRONICS CO., LTD.**

Office: No. 6-8, Zhonghua Rd., Shulin Dist.,

New Taipei City 23860, Taiwan

Tel: 886-2-2685-6688

Fax: 886-2685-2699 , 6897

<http://www.everlight.com>