

Limitless™ Wireless Monitor WPMM Series

002318

Issue 5

Datasheet



DESCRIPTION

The Honeywell WPMM Series Wireless Panel-Mount Monitor is designed to receive a wireless signal from a Honeywell Limitless™ device. When the WPMM monitor receives the signal, the monitor provides indication of a wireless device change-of-state via integral LEDs, audible alarm, and the output turning on. Output types include NPN, PNP, or a solid state relay. While the WPMM monitor is designed primarily for a single wireless device, the monitor can accept signals from multiple wireless devices. The monitor will acknowledge when a signal is received, but not necessarily identify which wireless device transmitted the signal. Refer to the WDRR Series (Limitless™ Din-rail receiver) datasheet to learn more about where each specific wireless input signal is identified with the WDRR receiver.

DIFFERENTIATION

- WPMM monitor, with the latest state-of-the-art wireless technology, provides a premium solution when paired with Honeywell's rugged metal wireless limit switches and operator interfaces
- Can reduce installation and maintenance costs with no wires, conduit, strain reliefs, clips, connectors, or junction boxes
- Field pairing (communications) function between host WPMM monitor and limit switches/operator interfaces allows for rapid configuration or any future field revised configurations

FEATURES

- Radio (license-free and global); WPAN 802.15.4, 2.4 GHz, point-to-point, providing reliable, flexible, and secure wireless transmission
- Certifications for global use (reference specifications, page 2)
- Up to 305 m [1000 ft] line-of-sight communication range when paired with a Limitless™ switch (sold separately)
- Supply voltage of 10 Vdc to 30 Vdc with output options of NPN, PNP, or solid state relay
- EMI immunity
- REACH and RoHS compliant

POTENTIAL APPLICATIONS

- Valve position
- Crane: boom/jib/skew position
- Grain gates or diverters
- Lifts
- Material handling
- Construction/ag equipment
- Door/gate position
- Conveyors
- Specialty machines

VALUE TO CUSTOMERS

- An alternative approach to communication with switching devices where wiring or wire maintenance is not physically possible or economically practical
- The wireless concept between the WPMM monitor and wireless switching device eliminates the hard wiring and hardware associated with the wiring saving on installation time, and reducing maintenance costs
- Products available with agency certifications for global use and Honeywell global application support
- Field pairing function allows for rapid configuration (adding or removing sensing devices) to meet demanding system requirements
- Panel-mount monitor communicates with the traditional size 30 mm x 60 mm rugged wireless metal limit switches and the wireless operator interface (WOI)

PORTFOLIO

The WPMM wireless monitor complements the Honeywell family of Limitless™ wireless product solutions.

Limitless™ Wireless Monitor, WPMM Series

Table 1. Specifications

Characteristic	Parameter
Series name	WPMM Series
Product type	Wireless Panel-Mount Monitor Series
Product availability	Global (with regional license-free bands based on location of use)
Housing material	Thermoplastic LCP (liquid crystal polymer)
Housing type	Snap-in panel or through-hole mount
Panel depth	82 mm less antenna
Radio type	WPAN 802.15.4, 2.4 GHz
Antenna connection/type	RP-SMA connection; Direct mount antenna or remote antenna; Omni directional
Signal range**	Nominal 305 m [1000 ft]* clear line-of-sight between Limitless™ input and monitor when using 2.2 dBi integral antenna
Supply voltage	10 Vdc to 30 Vdc
Output type	Standard, NPN normally open; Optional, PNP normally open or solid state relay
Load current	NPN (5 ma to 200 ma); PNP (150 ma max.); SSR (120 ma max.)
Leakage current	NPN (50 µa max.); PNP (50 µa max.); SSR (5 µa max. in OFF state)
Voltage drop	NPN (1.75 Vdc max.); PNP (4.5 Vdc max.); SSR (n/a)
Vout (with SSR closed) (typ.)	Vs -3.3 Vdc min.
Vout (with SSR open)	0.5 Vdc max.
Electrical connection	3 terminals (plus, minus, output) 6,35 mm x 0,81 mm [0.25 in x 0.032 in]
Reverse polarity protection	yes
EMC	Latest applicable standards: EN 300 328, V1.7.1; EN61326-1 (2006); EN 301 489-1, V1.8.1; EN 301 489-17, V2.1.1
Sealing	IP67
Shock	IEC 60068-2-27; half sine, 10 g, 6 ms, 3 axis
Vibration	IEC 60068-2-6; 10 Hz to 58 Hz, with 0,35 mm peak-to-peak; 58 Hz to 500 Hz @ 5 g
Operating temperature	-40 °C to 85 °C [-40 °F to 185 °F]
UNSPSC code	20142601
UNSPSC commodity	20142601
Agency certifications	FCC 15.247 (United States); IC RSS 210 (Canada); ETSI (CE); ACMA, C-Tick (Australia); ANATEL (Brazil); SRRC (China); WPC (India); SII (Israel); KCC (Korea); COFETEL (Mexico); IDA (Singapore); RoHS and REACH Compliant

* Actual range will vary depending on antenna, cables, and site topography.

** Line of sight is not mandatory to fully utilize the Limitless™ technology, and thus testing in the actual application will determine suitability.

Limitless™ Wireless Monitor, WPMM Series

PRODUCT NOMENCLATURE

WPMM	1	A	00	A	
Switch type	Gen Code	RF Code	Antenna Type Code	Country Use Code	Specials
WPMM Series Panel-Mount Monitor	1 Version 1	A 2.4 GHz; IEEE 802.15.4	00 No antenna; RP-SMA connector jack	A US, Canada, Mexico	For specials, please see the Limitless™ WPMM Installation Drawing.
			01 2.2 dBi omni with direct mount; straight design	B All other approved countries ^{1,2,3}	
			02 2.2 dBi omni with direct mount; tilt/swivel	¹ Use with antenna type codes 00 - 03, 05, 10, 11 only; usage also allowed in Country Code A.	
			03 3.0 dBi omni with remote adhesive mount 9.8 ft cable	² Some countries require specific communication certifications. Contact Honeywell for existing certification information.	
			04 5.5 dBi omni with remote magnetic mount, tilt/swivel, 5 ft cable ^A	³ If Limitless™ devices are used on machinery that may be shipped globally, use Country Code "B".	
			05 5.5 dBi omni with remote magnetic mount, tilt/swivel, 10 ft cable ^A		
			06 9.0 dBi omni with remote magnetic mount, tilt/swivel, 5 ft cable ^A		
			07 9.0 dBi omni with remote magnetic mount, tilt/swivel, 10 ft cable ^A		
			08 8.0 dBi omni with remote bracket mount, straight design, 3 ft cable		
			09 8.0 dBi omni with remote bracket mount, straight design, 11 ft cable		
		10 2.2 dBi omni with remote magnetic mount, tilt/swivel, 10 ft cable			

^A User must protect antenna from moisture ingress.

Limitless™ Wireless Monitor, WPMM Series

Table 2. Order Guide

	Catalog Listing	Description
	WPMM1A00A	Monitor without antenna for use in Canada, US, and Mexico
	WPMM1A00AP01	Monitor without antenna with PNP output for use in Canada, US, and Mexico
	WPMM1A00B	Monitor without antenna for use in all other approved countries
	WPMM1A00BP01	Monitor without antenna with PNP output for use in all other approved countries
	WPMM1A01A	Monitor with 2.2 dBi omni antenna (straight design) direct mount for use in Canada, US, and Mexico
	WPMM1A01B	Monitor with 2.2 dBi omni antenna (straight design) direct mount for use in all other approved countries
	WPMM1A02A	Monitor with 2.2 dBi omni antenna (tilt & swivel design) direct mount for use in Canada, US, and Mexico
	WPMM1A02AP01	Monitor with 2.2 dBi omni antenna (tilt & swivel design) direct mount with PNP output for use in Canada, US, and Mexico
	WPMM1A02AS01	Monitor with 2.2 dBi omni antenna (tilt & swivel design) direct mount with non-isolated solid state relay for use in Canada, US, and Mexico
	WPMM1A02B	Monitor with 2.2 dBi omni antenna (tilt & swivel design) direct mount for use in all other approved countries
	WPMM1A03A	Monitor with 3.0 dBi omni antenna (remote adhesive mount & 3 m [10 ft] cable) for use in Canada, US, and Mexico
	WPMM1A03B	Monitor with 3.0 dBi omni antenna (remote adhesive mount & 3 m [10 ft] cable) for use in all other approved countries
	WPMM1A04A***	Monitor with 5.5 dBi omni antenna (remote magnetic mount tilt & swivel with 1.5 m [5 ft] cable) for use in Canada, US, and Mexico
	WPMM1A04B***	Monitor with 5.5 dBi omni antenna (remote magnetic mount tilt & swivel with 1.5 m [5 ft] cable) for use in all other approved countries
	WPMM1A05A***	Monitor with 5.5 dBi omni antenna (remote magnetic mount tilt & swivel with 3 m [10 ft] cable) for use in Canada, US, and Mexico
	WPMM1A05B***	Monitor with 5.5 dBi omni antenna (remote magnetic mount tilt & swivel with 3 m [10 ft] cable) for use in all other approved countries
	WPMM1A10A	Monitor with 2.2 dBi omni antenna (remote magnetic mount straight design with 3 m [10 ft] cable) for use in Canada, US, and Mexico
	WPMM1A10B	Monitor with 2.2 dBi omni antenna (remote magnetic mount straight design with 3 m [10 ft] cable) for use in all other approved countries
	WPB1	Metal mounting bracket (right angle) for WPMM Series monitor
	WPR1	Panel-mount plastic retainer for WPMM Series monitor

*** User must protect antenna from moisture ingress.

Limitless™ Wireless Monitor, WPMM Series

DIMENSIONS • WPMM

Figure 1. WPMM Dimensions

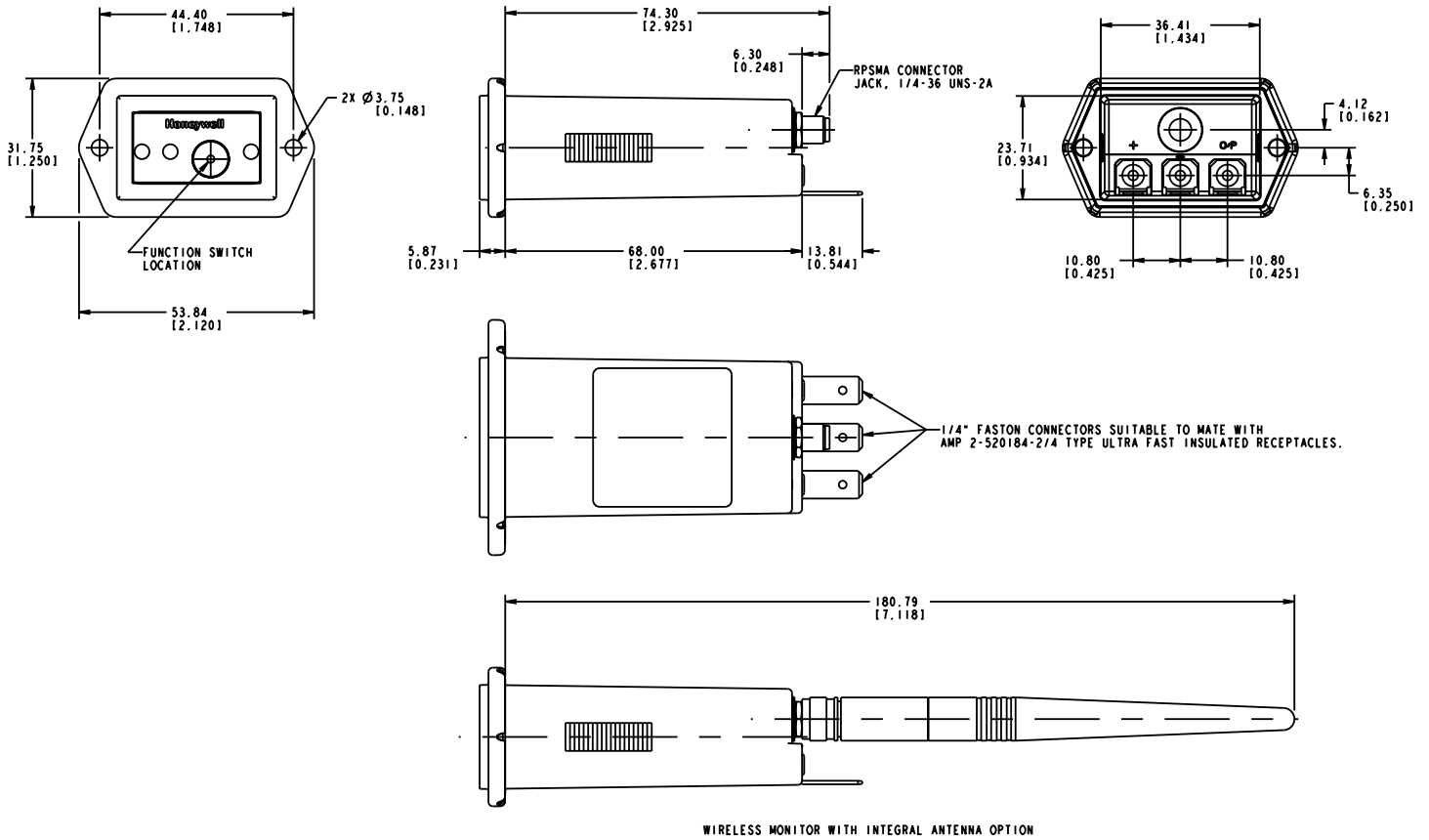
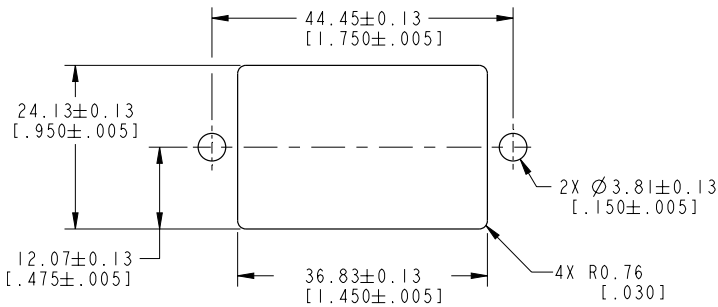

Figure 2. WPMM Mounting Hole Dimensions



Limitless™ Wireless Monitor, WPMM Series

DIMENSIONS • MOUNTING ACCESSORIES, WPB

Figure 3. WPB1 Bracket Dimensions

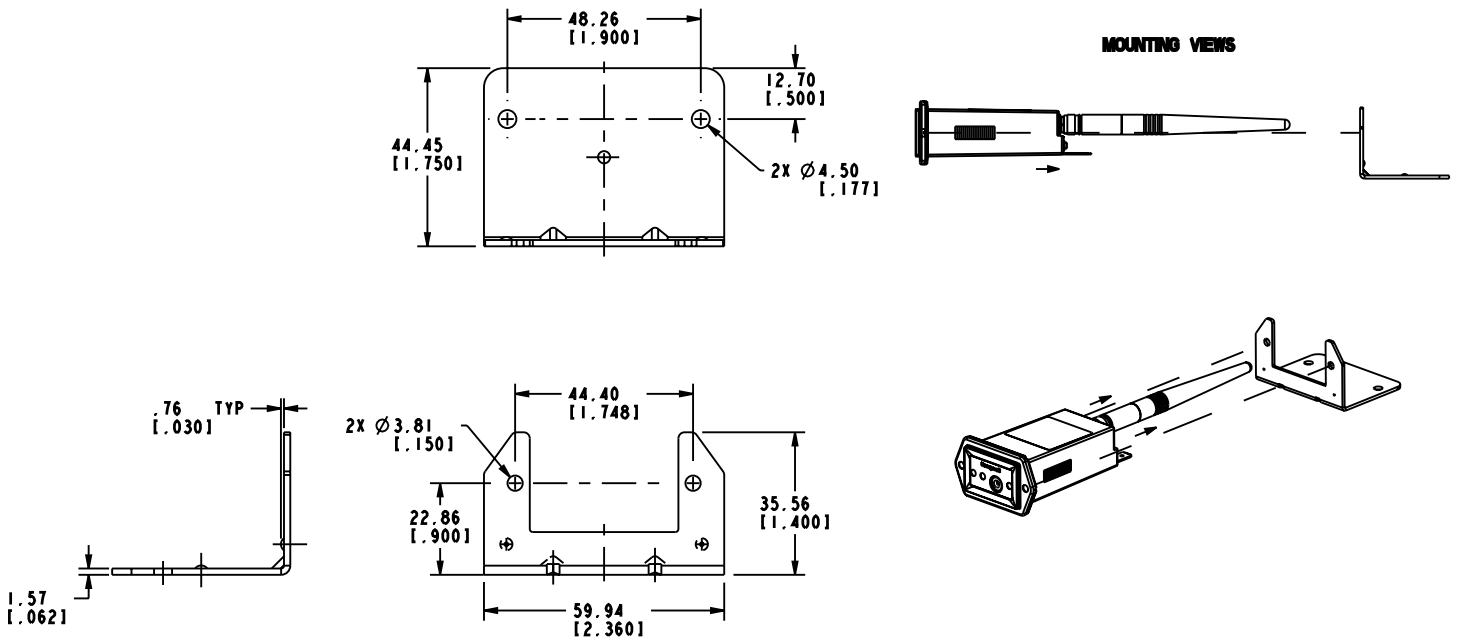
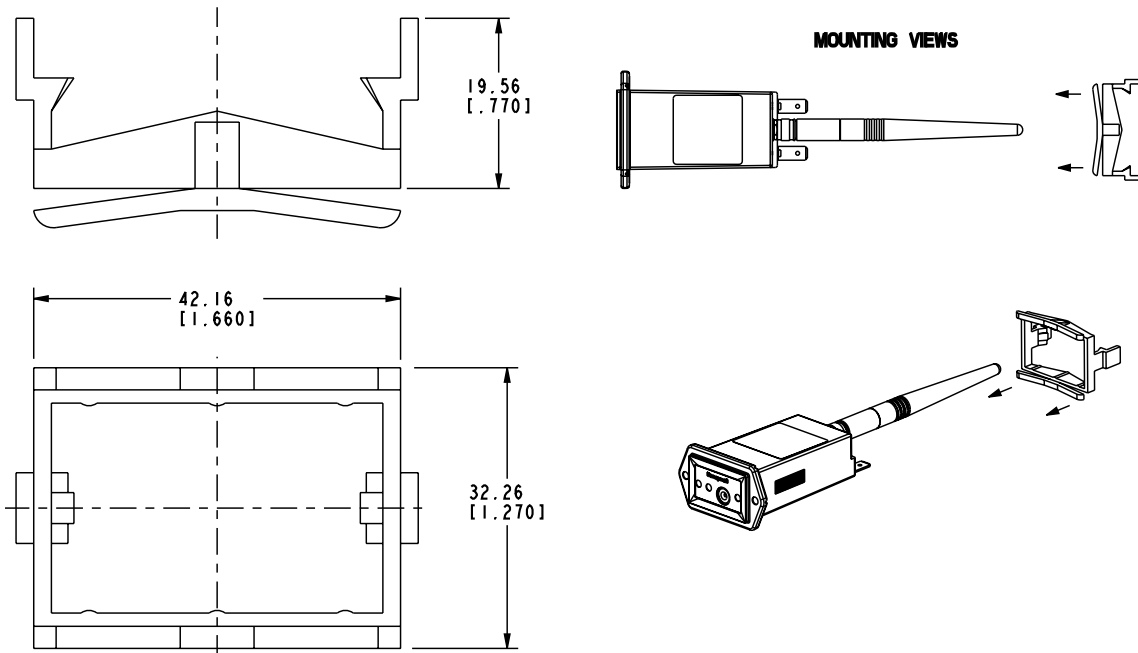













Figure 4. WPR1 Retainer Dimensions



Limitless™ Wireless Monitor, WPMM Series

Table 3. Antenna Listings/Order Code Specifications

Antennas can be ordered with the Limitless™ wireless monitors by inserting the **Antenna Type Code** into the part number as shown in the nomenclature. Also, monitors can be ordered without antennas, by using the “00” Antenna Type Code in the part number. Antennas may also be ordered separately using the **Part Numbers** below.

	Part Number (if ordered separately)	Antenna Type Code (if ordered with the monitor)		Antenna Design	Antenna Gain (dBi)	Connector/ Mounting	Dimensions
	WAN01RSP	01		straight	2.2	RP-SMA plug/direct mount	Ø 9,91 mm x 112,78 mm L [Ø 0.39 in x 4.44 in L]
	WAN02RSP	02		tilt/swivel	2.2	RP-SMA plug/direct mount	Ø 9,91 mm x 112,78 mm L [Ø 0.39 in x 4.44 in L]
	WAN03RSP	03		flat	3.0	RP-SMA plug/adhesive mount	Ø 7,87 mm x 22,1 mm W x 4,57 mm D [Ø 0.31 in x 0.87 in W x 0.18 in D] 3 m [9 ft] cable
	WAN04RSP*	04** with a WAMM100RSP-005 base with 1,52 m [5 ft] of cable	05** with a WAMM100RSP-010 base with 3,05 m [10 ft] of cable	tilt/swivel	5.5	RP-SMA plug/direct mount	Ø 12,7 mm x 208,28 mm L [Ø 0.50 in x 8.20 in L]
	WAN05RSP*	06** with a WAMM100RSP-005 base with 1,52 m [5 ft] of cable	07** with a WAMM100RSP-010 base with 3,05 m [10 ft] of cable	tilt/swivel	9.0	RP-SMA plug/direct mount	Ø 12,7 mm x 384,05 mm L [Ø 0.50 in x 15.12 in L]
	WAN06RNJ*	08** with a WCA200RNPRSP-002 coax cable assembly, 0,682 m [2 ft]	09** with a WCA200RNPRSP-010 coax cable assembly, 3,05 m [10 ft]	straight	8.0	RP-N jack/ bracket	Ø 33,5 mm x 427,9 mm L [Ø 1.32 in x 16.85 in L]
	WAN07RSP	11		straight	0.0	RP-SMA plug/direct mount	Ø 8,0 mm x 30 mm L [Ø 0.32 in x 1.18 in L]
	WAN08RSP	-		90°	0.0	RP-SMA plug/direct mount	Ø 8,0 mm x 29 mm L [Ø 0.32 in x 1.14 in L]
	WAN09RSP	-		low profile mobile	3.0	RP-SMA plug/magnetic	Ø 76,2 mm x 115 mm L [Ø 3.0 in x 4.54 in L] 3,05 m [10 ft] cable
	WAN10RSP	-		straight	5.0	RP-SMA plug/magnetic	Ø 76,2 mm x 230,1 mm L [Ø 3.0 in x 9.06 in L] 4,57 m [15 ft] cable
	WAN11RSP*	-		low profile mobile dome	4.0	RP-SMA plug/thru-hole screw	Ø 39 mm x 42,4 mm L [Ø 1.54 in x 1.67 in L]

* Not allowed for use with Country Code “B” Limitless™ products.

** See Tables 4 and 5 (page 8) for accessories.

Limitless™ Wireless Monitor, WPMM Series

ACCESSORIES

Table 4. Cable and Coax Accessories











	Part Number	Description
	WCA200RNPRSP-002	Limitless™ Series wireless cable assembly with 200 Series cable, 2 ft length, reverse polarity N plug to reverse polarity SMA plug, use only with WAN06RNJ antenna
	WCA200RNPRSP-010	Limitless™ Series wireless cable assembly with 200 Series cable, 10 ft length, reverse polarity N plug to reverse polarity SMA plug, use only with WAN06RNJ antenna
	WCA200RNJRSP-002	Limitless™ Series wireless cable assembly with 200 Series cable, 2 ft length, reverse polarity SMA jack to reverse polarity SMA plug
	WCA200RNJRSP-005	Limitless™ Series wireless cable assembly with 200 Series cable, 5 ft length, reverse polarity SMA jack to reverse polarity SMA plug
	WCA200RNJRSP-010	Limitless™ Series wireless cable assembly with 200 Series cable, 10 ft length, reverse polarity SMA jack to reverse polarity SMA plug
	WCA200RNJRSP-015	Limitless™ Series wireless cable assembly with 200 Series cable, 15 ft length, reverse polarity SMA jack to reverse polarity SMA plug
	WCA200RNJRSP-020	Limitless™ Series wireless cable assembly with 200 Series cable, 20 ft length, reverse polarity SMA jack to reverse polarity SMA plug

Table 5. Base Accessories

	Part Number	Description
	WAMM100RSP-005	Magnetic antenna base with 1,52 m [5 ft] of cable
	WAMM100RSP-010	Magnetic antenna base with 3,05 m [10 ft] of cable
	WPB1	WPMM wireless panel-mount receiver mounting bracket
	WPR1	WPMM panel-mount retainer

ADDITIONAL MATERIALS

The following associated literature is available at sensing.honeywell.com:

- Product range guide
- Product installation instructions
- Product brochure
- Product application-specific information
- White Paper: Limitless™ Switches Offer Unlimited Benefits

Find out more

Honeywell serves its customers through a worldwide network of sales offices, representatives and distributors. For application assistance, current specifications, pricing or name of the nearest Authorized Distributor, contact your local sales office.

To learn more about Honeywell's sensing and switching products, call **+1-815-235-6847** or **1-800-537-6945**, visit **sensing.honeywell.com**, or e-mail inquiries to **info.sc@honeywell.com**

Sensing and Productivity Solutions
Honeywell
1985 Douglas Drive North
Golden Valley, MN 55422
honeywell.com

⚠ WARNING **PERSONAL INJURY**

DO NOT USE these products as safety or emergency stop devices or in any other application where failure of the product could result in personal injury.

Failure to comply with these instructions could result in death or serious injury.

⚠ WARNING **MISUSE OF DOCUMENTATION**

- The information presented in this product sheet is for reference only. Do not use this document as a product installation guide.
- Complete installation, operation, and maintenance information is provided in the instructions supplied with each product.

Failure to comply with these instructions could result in death or serious injury.

Warranty/Remedy

Honeywell warrants goods of its manufacture as being free of defective materials and faulty workmanship. Honeywell's standard product warranty applies unless agreed to otherwise by Honeywell in writing; please refer to your order acknowledgement or consult your local sales office for specific warranty details. If warranted goods are returned to Honeywell during the period of coverage, Honeywell will repair or replace, at its option, without charge those items it finds defective. **The foregoing is buyer's sole remedy and is in lieu of all other warranties, expressed or implied, including those of merchantability and fitness for a particular purpose. In no event shall Honeywell be liable for consequential, special, or indirect damages.**

While we provide application assistance personally, through our literature and the Honeywell web site, it is up to the customer to determine the suitability of the product in the application.

Specifications may change without notice. The information we supply is believed to be accurate and reliable as of this printing. However, we assume no responsibility for its use.

Honeywell