

uEZGUI Users Manual

Covers the following products:
uEZGUI-1788-70WVT



Copyright ©2012, Future Designs, Inc., All Rights Reserved

FDI ***Future Designs, Inc.***
Your Development Partner
2702 Triana Boulevard SW, Huntsville, AL 35805

Table of Contents

1. Introduction	2
2. Block Diagram	2
3. Functional Description	3
4. Startup procedure	3
5. Demonstration Software Main Menu	4
6. Setting up a Slideshow	5
7. Software	5
8. Configuring Rowley CrossWorks CrossStudio for ARM® for J-Link Flashing	6
9. Configuring IAR EWARM v6.10 for J-Link Flashing	7
10. Configure Keil uVison 4 for J-Link Flashing	8
11. Template Project	8
12. Functional Test Software	11
13. Board Layout	11
14. I/O Connector Descriptions	12
JTAG Connector	12
MicroSD Connector	14
ISP Connector (not loaded)	14
Expansion Connectors	14
Expansion Connector Cable Details	19
15. Mechanical Details	19
ESD Warning	20
16. Power Requirements	20
17. Useful links	20
18. Schematics	20
19. Temperature Range	21

Information in this document is provided solely to enable the use of Future Designs products. FDI assumes no liability whatsoever, including infringement of any patent or copyright. FDI reserves the right to make changes to these specifications at any time, without notice. No part of this document may be reproduced or transmitted in any form or by any means, electronic or mechanical, for any purpose, without the express written permission of Future Designs, Inc. 2702 Triana Blvd, Huntsville, AL 35805.

For more information on FDI or our products please visit www.teamfdi.com.

NOTE: The inclusion of vendor software products in this kit does not imply an endorsement of the product by Future Designs, Inc.

© 2012 Future Designs, Inc. All rights reserved.

uEZ® is a registered trademark of Future Designs, Inc.

Microsoft, MS-DOS, Windows, Windows XP, Microsoft Word are registered trademarks of Microsoft Corporation.

Other brand names are trademarks or registered trademarks of their respective owners.

FDI PN:

Revision: 1, 2/23/2012

Printed in the United States of America

1. Introduction

The uEZGUI-1788-70WVT provides a quick and easy solution for implementing a Graphical User Interface (GUI) based design by providing the basic functions necessary for most customer products.

2. Block Diagram

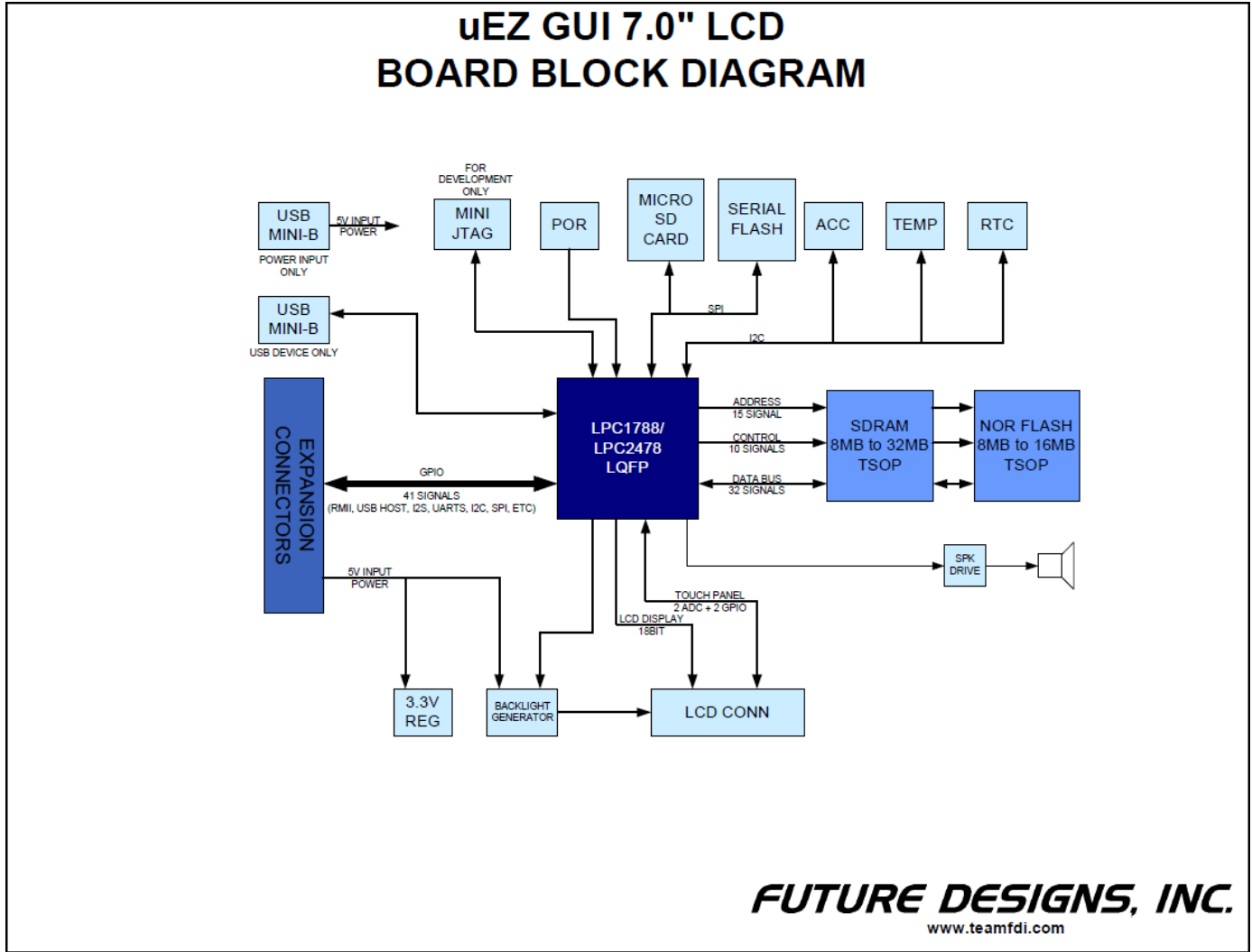

Figure 1 – uEZGUI-1788-70WVT Block Diagram

3. Functional Description

- LPC1788 Cortex-M3 based Microprocessor
- SDRAM 8MB, optional up to 16MB
- NOR FLASH 8MB, optional up to 16MB
- Serial EEPROM with Access Protection (optional)
- Internal 4kB EEPROM
- RTC – Real Time Clock
- Temperature Sensor
- 3-axis Accelerometer
- Optional 128Mbit Serial Flash
- Optional WiFi Module
- Speaker
- Micro SD Card Socket for up to 2GB storage (SDHC currently not supported)
- Mini JTAG
- ISP Connector for use with USP-ICP-LPC2K
- Power-on Reset Generator - power-on reset supervisor and voltage monitor (SW1)
- Expansion Connector for customer specific applications

4. Startup procedure

The uEZ GUI kit comes with a pre-installed 2 GB micro SD card that contains files required for the slide show to run. It also contains users' manuals, schematics, and documentation for the product.

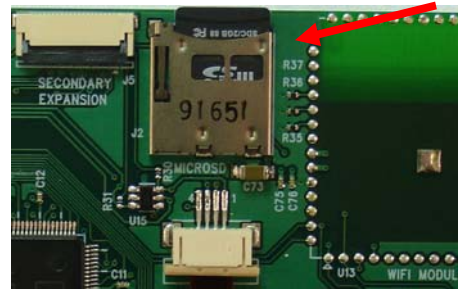
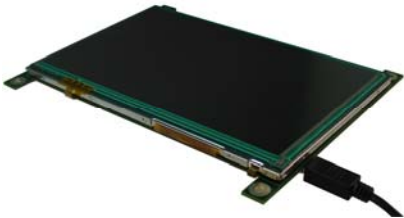

Power is supplied via a USB cable and power supply provided in the kit. Connect the USB cable to the mini B USB connector labeled 5V 1A min input only.

The following screens should appear once power has been applied to the kit:



At this point the unit is ready for software demonstrations and user operation.

The uEZGUI will appear as a USB Flash Drive to the PC, allowing the user to read/write files directly to the Micro SD card.

5. Demonstration Software Main Menu

The Demonstration Software has the following options:

Slideshow

Selecting the slideshow icon will cause the Micro SD card to be read. This demonstration allows the user to select between several slideshow options such as “Introduction to uEZ GUI”, “Demonstration Pictures”, “FDI Overview”, “Strategic Partners”, etc. Select the play button to begin the automated slide show or manually by “dragging” a stylus or finger at least half way across the screen. After approximately 30 seconds of no activity the slideshow will begin to auto scroll. The user can regain manual control at any time by “dragging” forward or backwards to the next slide. Click on the “X “to return to the main menu.

The following programs appear under the “Apps” icon:

Accelerometer

Selecting this icon demonstrates the accelerometer feature by moving a simulated ball across the screen as the board is tilted along the X and Y axis. To return to the main menu touch the exit icon.

Time and Date

This feature displays the current time and date from the external Real Time Clock (RTC). Touch “Time” to advance to the “Set Time” screen or touch “Date” to advance to the “Set Date” screen and set or update the date as necessary. To change the time or date simply click on the section you want to change and increase or decrease using the up and down indicators. Once set an on-board super cap will back-up the time and date for several days (typically) if the unit is powered off. To return to the main menu touch the exit icon.

Temperature

Selecting this icon displays the temperature from the LM75 temperature sensor. To select between Celsius and Fahrenheit click the “C” or “F” to change. To return to the main menu touch the exit icon.

Exit the “Apps” Icon to the main screen and the following programs are available

Communications

This option is only valid on uEZGUI-1788-70WVT with attached uEZGUI-EXP1.

Settings ICON

Calibrate use this feature to calibrate the LCD for the first time or if corrections are required.

Functional Test is a step by step test of the following parameters:

- Speaker test
- LCD color test
- SDRAM size test
- Temperature
- EEPROM test
- NOR Flash Memory test

Draw

A very simple art program is provided. Use the touch screen to draw lines in the box to the right. Clicking on **Color** allows the color to be changed between various options. Hint – use black to erase. **Save** stores the graphic

image as the file IMAGE.RAW on the Micro SD card. **Load** recalls the saved graphic image from the Micro SD card.

6. Setting up a Slideshow

The Slideshow demonstration loads and scrolls between images provided on a SD micro card. Images must be in 24 bit uncompressed Targa (.TGA) format. Adobe Photoshop and many other graphics programs can save images in this format. The images must be 800x480 and 11.11"x6.67" in size and use the file names WVSLIDExx.TGA where xx is 00 thru 99. (i.e. WVSLID01.tga, WVSLID02.tga, etc).

Images must be stored in a directory under /SLIDES. Edit the file "SLIDES.TXT" by adding a line in the following format: "<title>,<directory>". The field <title> is the text shown when selecting a slideshow. The field <directory> is the subdirectory in which the slides are found. The field <directory> must be 8 characters or less.

NOTE: Currently, the uEZ GUI will only allow selection of the top four entries of "SLIDES.TXT".

Place the pictures created above in the subdirectory listed in the "SLIDES.TXT" file. For example, entry "uEZGUI-1788-70WVT,UEZGUI" puts up a title of "uEZGUI-1788-70WVT" and loads the slides (WVSLID01.TGA to WVSLID08.TGA) from the directory /SLIDES/UEZGUI.

7. Software

μEZ[®] takes its name from the Muses of Greek mythology. A Muse was a goddess who inspired the creation process for the arts and sciences. Like its ancient Greek namesake, the **μEZ**[®] platform inspires rapid development by supplying customers with an extensive library of open source software, drivers, and processor support - all under a common framework. **μEZ**[®] development works on the premise of "design once, reuse many times". This provides an open source standard for embedded developers to build upon and support. **μEZ**[®] allows companies to focus on innovation and on their own value-added applications while minimizing development time and maximizing software reuse.

The diagram below shows a typical embedded application stack. **μEZ**[®] has three primary categories of components that help simplify embedded application development:

1. **Operating System Abstraction Layer (μEZ[®] OSAL)**
2. **Sub-system drivers (μEZ[®] TCP/IP, μEZ[®] USB, μEZ[®] Driver)**
3. **Hardware Abstraction Layer (μEZ[®] HAL)**

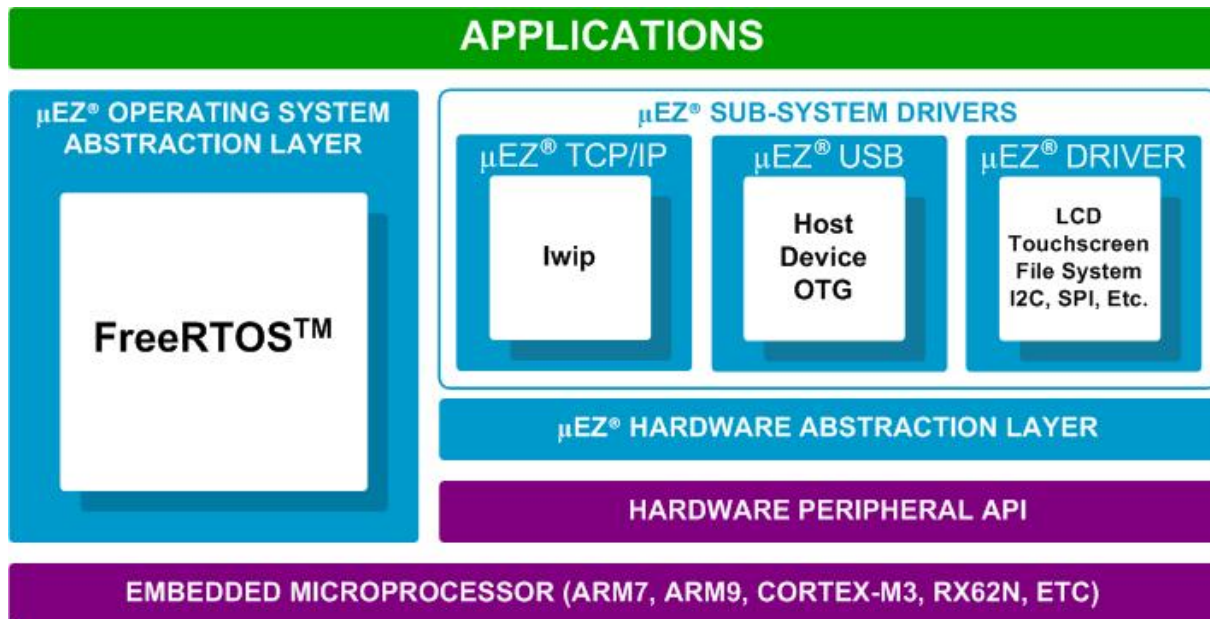

The selection of an RTOS can be one of the most daunting aspects of an embedded system development. With **μEZ®** the primary features of common multi-tasking operating systems are abstracted, thus easing the transition to an open source or low-cost RTOS. The **μEZ®** OSAL provides applications access to the following features in an OS-independent fashion:

- Pre-emptive multitasking
- Stack overflow detection
- Unlimited number of tasks
- Queues
- Semaphores (binary, counting, mutex)

The **μEZ®** sub-system drivers utilize the OSAL functions to provide protected access to the processor peripherals. The sub-system driver API functions are typically protocol layer interfaces (TCP/IP, USB, etc) designed as high-level access routines such as open, close, read, write, etc. where possible.

μEZ® is ideally suited for Embedded Systems with standard features such as:

- Processor and Platform BSPs (Board Support Packages)
- Real Time Operating System (RTOS)
- Memory Management
- NAND/NOR Flash
- SDRAM and DDR Memory
- TCP/IP stack
- USB Device/Host Libraries
- Mass Storage Devices
- LCD Displays with Touch Screen
- Input / Output Devices

8. Configuring Rowley CrossWorks CrossStudio for ARM® for J-Link Flashing

- 1) See the document “**μEZ®** Software Quickstart Guide” for details on how to download the **μEZ®** source code and setup the Rowley CrossWorks compiler.

(<http://www.teamfdi.com/uez/files/MA00015%20uEZ%20Software%20Quickstart%20Guide.pdf>)

- 2) Plug in the J-Link device into the PC and install any drivers as directed. The Segger J-Link drivers can be found at <http://www.segger.com/cms/jlink-software.html> with additional information at <http://www.segger.com/cms/development-tools.html>.
- 3) Plug in the J-Link's JTAG connector to the uEZGUI board at J3 with the JTAG adapter.
- 4) Select **Target** menu and choose **Targets**. The following list will appear to the right.

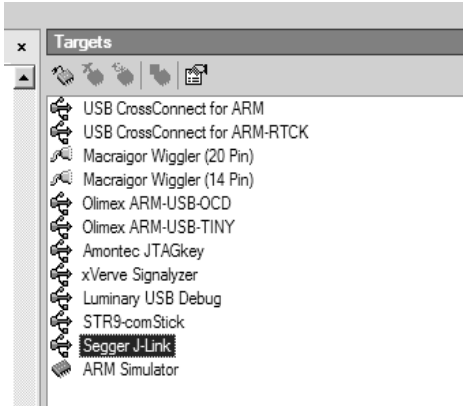

- 5) Right click on “Segger J-Link” and select Properties

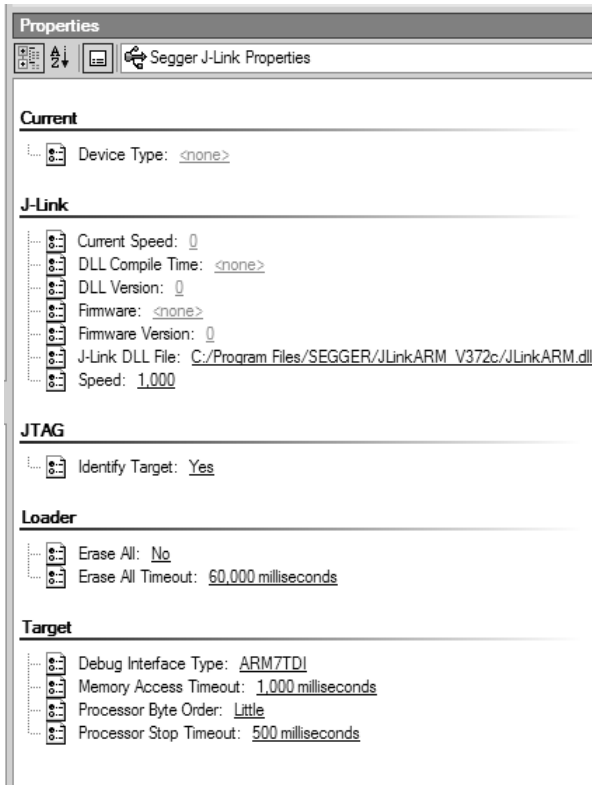

- 6) If programming a blank LPC1788 part, select a Speed of 100. If the part has already been programmed, select a Speed of 1000.
- 7) Go back to menu **Target** and select “Connect Segger J-Link”
- 8) Compile the application and press F5 to download and start debugging.

9. Configuring IAR EWARM v6.10 for J-Link Flashing

The IAR tools do not require any special configuration for configuring the J-Link tools. To update IAR's J-Link dll you just need to run Segger's J-Link DLL Updated and select the IAR install you wish to update and click Ok.

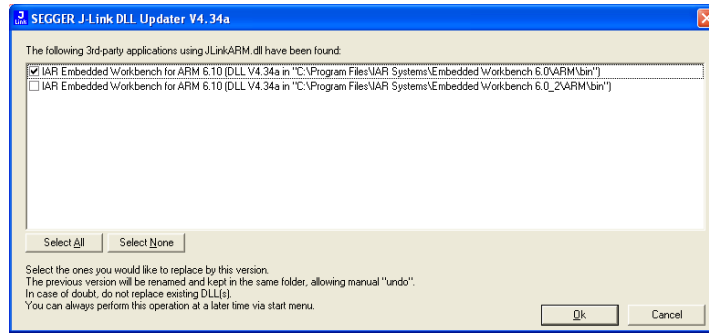

10. Configure Keil uVison 4 for J-Link Flashing

To configure Keil to use the following steps.

1. Click Flash from the Menu Bar and select Configure Flash Tools...
2. Click the Utilities Tab.
3. In the dropdown box for Use Target Driver for Flash Programming select the CORTEX-M/R J-LINK/J-Trace.

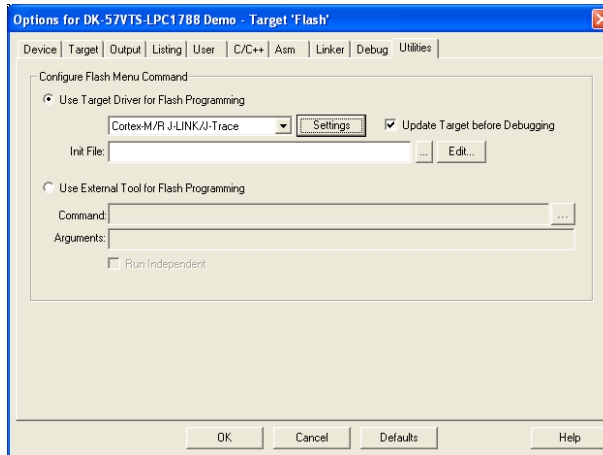

4. Click the Debug tab and select the same device for Use.

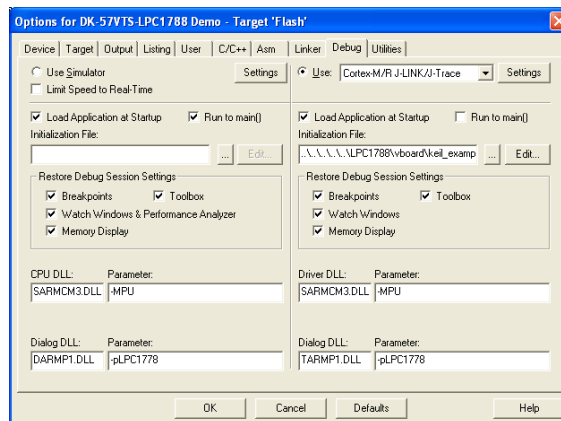

11. Template Project

Beginning in uEZ v1.12 projects will start using Platform Libraries for select platforms. Below is an example of the directory structure of the uEZGUI-1788-70WVE IAR 6.10 project. The uEZGUI-1788-70WVT and uEZGUI-1788-70WVE have similar project structures and the instructions for IAR are the same.

- FDIDemo – This is the project that the standard FDI demo uses.
- PlatformLib – This is the project that build the platform for the uEZGUI-1788-70WVE.
- Template – This project contains a limited demo and can be used as a starting point for new applications.

The template demo is a limited demo that passes control over to the Button Demo, this call can be replaced by your application. In the Button Demo four buttons are put on the screen and when pressed display a message on the screen. The IAR project is setup to be a multiple workspace solution to allow building the Platform and the application.

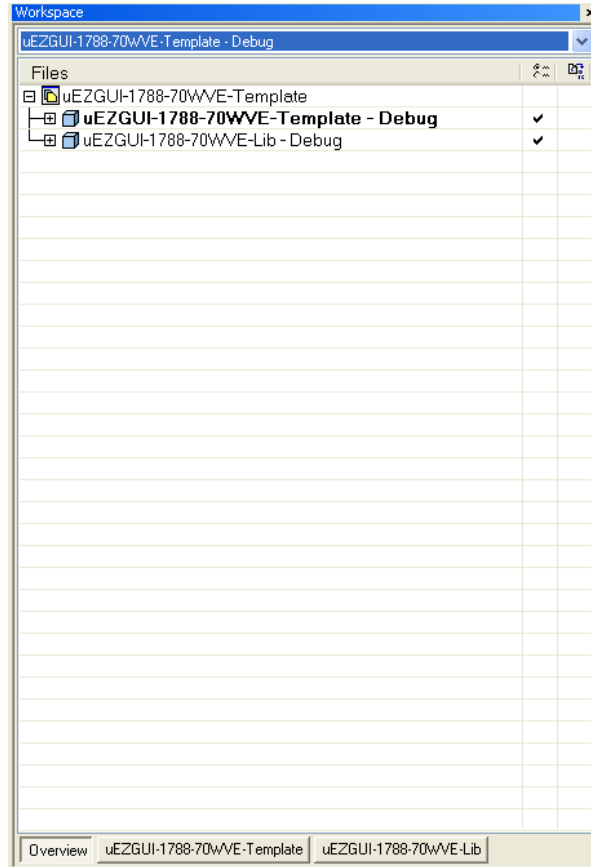

There are three tabs in the workspace window described below.

- Overview – High level view of the projects included.
- uEZGUI-1788-70WVE-Template – Project using the library to run the simple demo.
- uEZGUI-1788-70WVE-Lib – Project to build the Platform Library.

The first thing we will need to do is build the library. We have two options: Debug and Release. For now, we will start with Debug. Select “uEZGUI-1788-70WVE-Lib – Debug” in the workspace dropdown list.

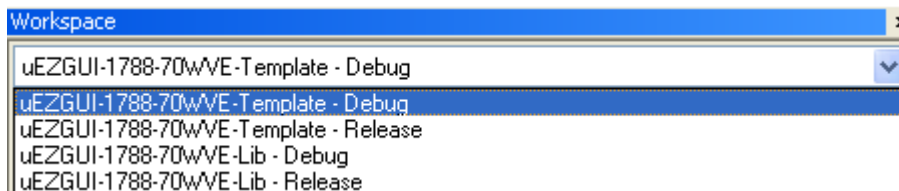

Press F7 to build the project. After compiling is finished switch back to “uEZGUI-1788-70WVT-Template –Debug”.

The default configuration is to link the debug library, but it can be switched by right clicking on the library and selecting options, then toggle the Exclude from project checkbox.

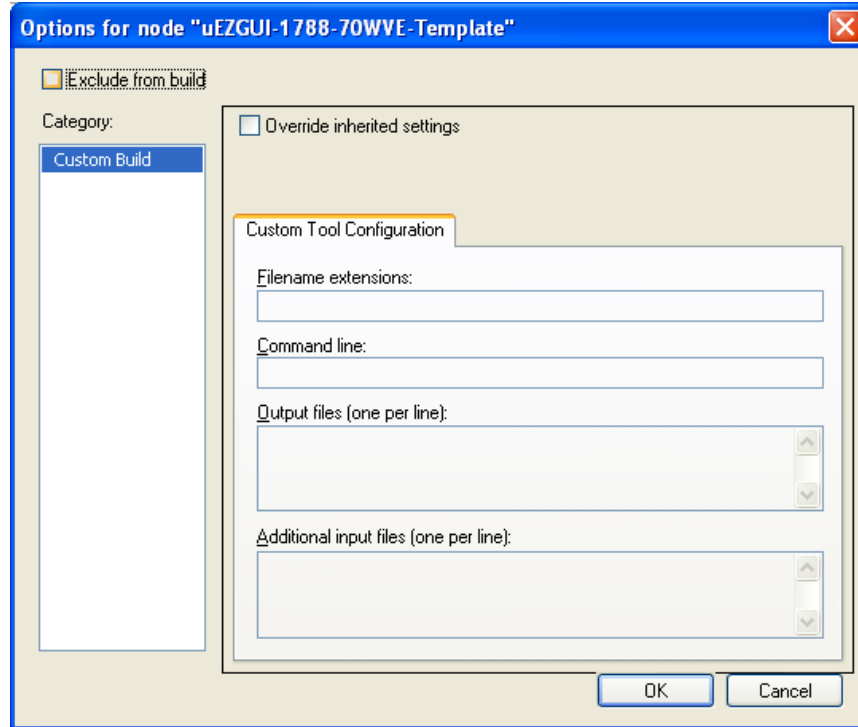

Press F7 to build the template project. After compiling has finished press the  download and debug button to start the demo. After the download has finished, pressed F5 to run the new program.

The demo code is located in the directory “Source\App\uEZ GUI\uEZGUI-1788-70WVE-Template” and can also be viewed by opening Source under the Template project.

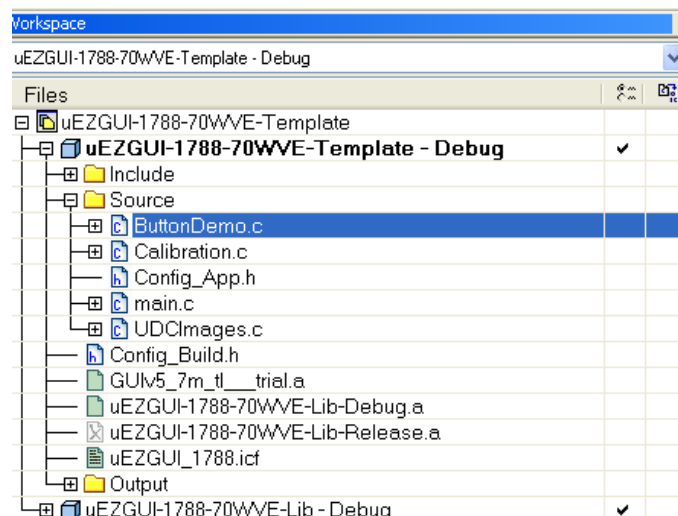

12. Functional Test Software

The Functional Test Software tests all the basic features of the uEZGUI-1788-70WVT Kit as follows.

Functional Test a step by step test of the following parameters:

- Accelerometer – Tests the presence of the accelerometer.
- EEPROM test - The EEPROM is tested for communication and integrity.
- LCD color test - Red, Green, and Blue are displayed in smooth bands to ensure the LCD lines are correct
- MicroSD – Looks for a Micro SD Card with the file “SLIDES/SLIDES.TXT”
- NOR Flash Memory test - basic test is performed to confirm read/write access.
- RTC – Sets the time and confirms the clock is running.
- SDRAM size test - Memory is sized and a basic test is performed to confirm read/write access.
- Speaker test - Tones are played and the User is asked to verify that they are heard.
- Temperature – the board has an external LM75A that is tested to be in a range of 20-30 C.

A final report of PASS or FAIL is displayed along with a list of any Skipped and Failed items.

13. Board Layout

The following figures illustrate the layout of the various components of the uEZGUI-1788-70WVT kit. They are for reference only and are subject to change.

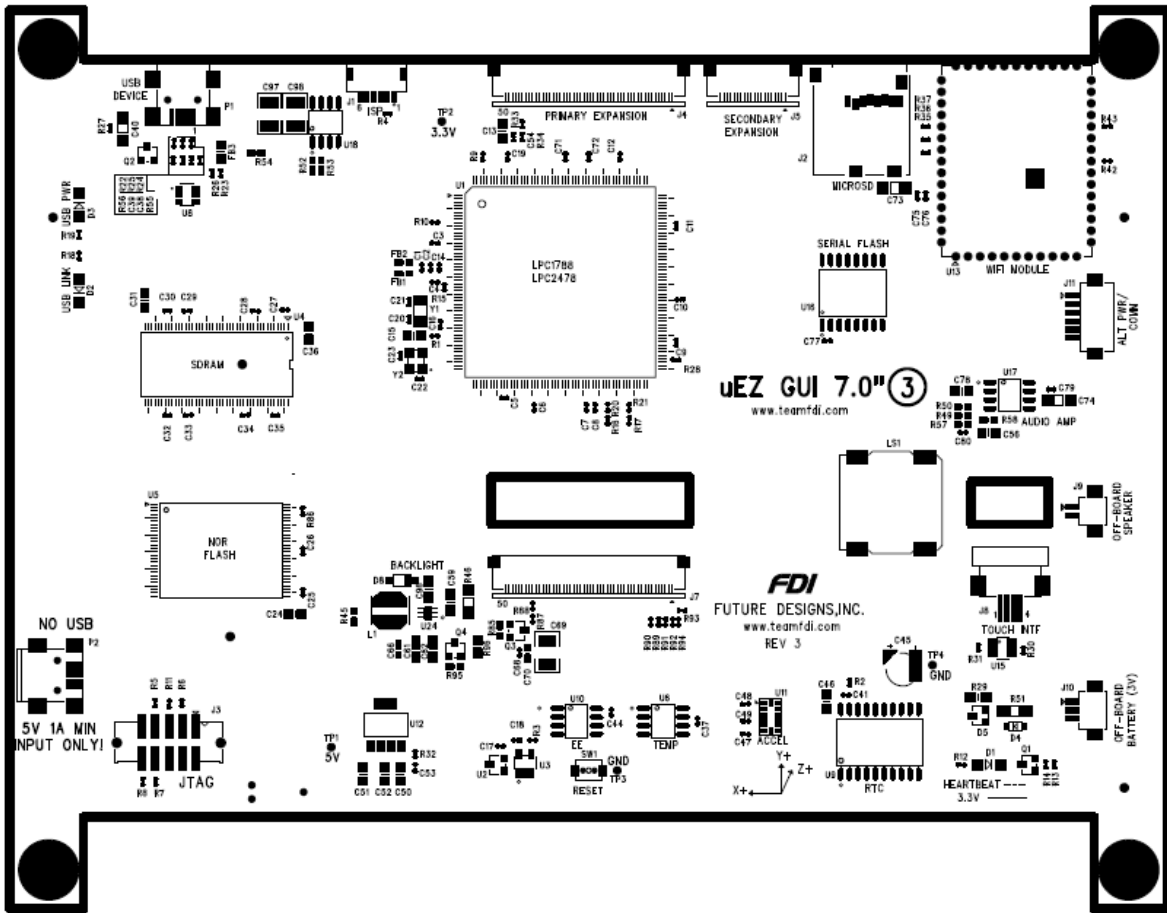

Figure 2 – uEZGUI-1788-70WVT Component View

14. I/O Connector Descriptions

JTAG Connector

The uEZGUI-1788-70WVT uses a reduced size JTAG connector based on a 2mm Header. This smaller connector provides 100% of the functionality of the standard 20-pin JTAG connector, but utilizes 70% less board space. The connector is a standard part available from most major vendors.

Pin Number	Description
1	GND
2	5.0V
3	TDO
4	RESETn
5	TCK
6	RTCK
7	TDI
8	TMS
9	3.3V
10	TRSTn

For users that may have existing JTAG debuggers, an adapter may be fabricated using the following wiring diagram: (part numbers for the connectors are included from both the manufacturer and Digi-Key)

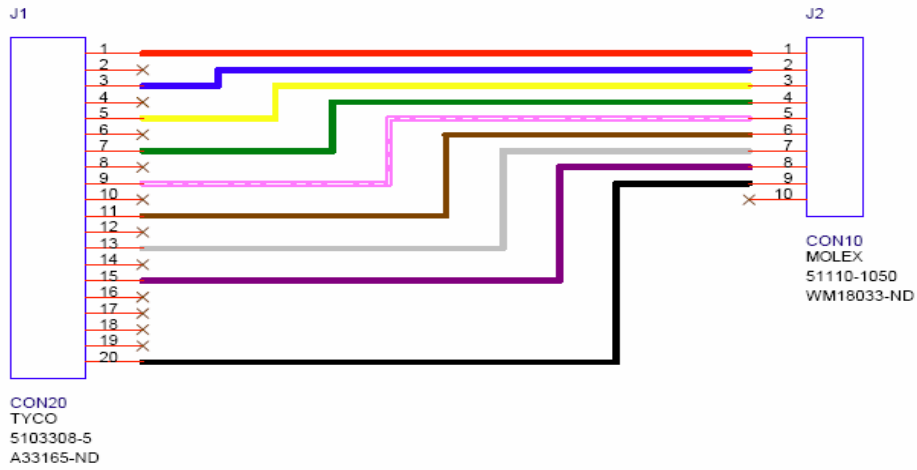

Figure 4 – Mini JTAG Adapter Wiring Diagram

Tag Connect

The uEZGUI-1788-70WVT also includes the ability to JTAG and program using the Tag-Connect TC2050-ARM2010 ARM 20-pin to TC2050 Adapter.

Adapter:

<http://www.tag-connect.com/tag-connect-2050-IDC-TG2050IDCNL>

Cable:

<http://www.tag-connect.com/TC2050-ARM2010>

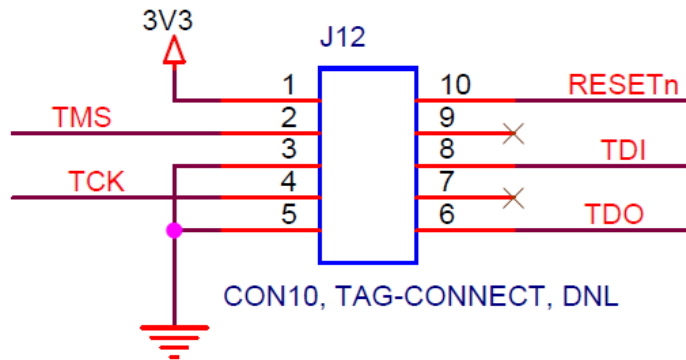

Figure 5 – Tag-Connect JTAG

MicroSD Connector

When connected to the USB Host port on a PC, the uEZGUI-1788-70WVT will appear as a USB Flash Drive to the PC, allowing the user to read and write files directly to the MicroSD card. The unit uses a MicroSD Socket for flexible mass storage capability. At this time, the uEZ[®] software does not support SDHC MicroSD Cards.

Pin Number	Description
1	NC
2	Micro SD Chip Select
3	Micro SD MOSI
4	3.3V
5	Micro SD SCLK
6	Ground
7	Micro SD MISO
8	NC

ISP Connector (not loaded)

The uEZGUI-1788-70WVT is laid out with an ISP programming header that is designed to be utilized with the USB-ICP-LPC2K programmer from FDI. This connector is a 1.5mm JST Male, shrouded connector. The JST Part Number is: SM06B-SHLS-TF. The pin out shown below is a direct, 1:1 connection to the USB-ICP-LPC2K programmer available from Future Designs, Digi-Key or Mouser.

Pin Number	Description
1	3.3V
2	Reset Input
3	ISP Entry
4	Ground
5	RXD
6	TXD

Expansion Connectors

The uEZGUI-1788-70WVT includes two expansion connectors that provide a wide variety of capabilities for user expansion, ranging from 10/100 Ethernet to USB Host, etc.

The tables below provide the pinout and signal names available on these connectors:

J4 Signal Details

Pin #	Pin Name	Pin Description	Input/output
1	Ground (GND)		Power
2	P0.11_RXD2_SCL2_MAT3.1	P0[11] - General purpose digital Input/Output pin.	Input/output
		RXD2 - Receiver input for UART2.	Input
		SCL2 - I2C2 clock Input/Output (this is not an open-drain pin)	Input/output
		MAT3[1] - Match output for Timer3, channel 1.	Output
3	P0.10_TXD2_SDA2_MAT3.0	P0[10] - General purpose digital Input/Output pin.	Input/Output
		SDA2 - I2C2 data Input/Output (this is not an open-drain pin).	Input/Output
		MAT3[0] - Match output for Timer3, channel 0.	Output
		TXD2 - Transmitter output for UART2.	Output
		P0[20] - General purpose digital Input/Output pin.	Input/Output

4	P0.20_DTR1_MCICMD	DTR1 - Data Terminal Ready output for UART1	Output
		SCL1 - I2C1 clock Input/Output (this is not an open-drain pin).	Input/Output
5	P0.19_DSR1_MCICLK	P0[19] - General purpose digital Input/Output pin.	Input/Output
		SDA1-I2C1 data Input/Output (this is not an open-drain pin).	Input/Output
		DSR1 - Data Set Ready input for UART1.	Input
6	P0.22_MCIDAT0_RTS1	P0[22] - General purpose digital Input/Output pin.	Input/Output
		RTS1 - Request to Send output for UART1.	Output
7	P0.17_CTS1	P0 [17] - General purpose digital Input/Output pin	Input/Output
		CTS1 - Clear to Send input for UART1.	Input
		MISO - Master In Slave Out for SPI.	Input/Output
		MISO0 - Master In Slave Out for SSP0.	Input/Output
8	P0.16_RXD1	P0[16] - General purpose digital Input/Output pin.	Input/Output
		SSEL0 - Slave Select for SP0.	Input/Output
		RXD1 - Receiver input for UART1.	Input
9	P0.15_TXD1	P0[15] - General purpose digital Input/Output pin.	Input/Output
		SCK0 - Serial clock for SSP0.	Input/Output
		TXD1 – Transmitter output for UART1.	Output
		SCK - Serial clock for SPI.	Input/Output
10	Ground (GND)		Power
11	USB1_DM	P0[30] - General purpose digital Input/Output pin.	Input/Output
		USB_D- 1 - USB port 1 bidirectional D- line.	Input/Output
12	USB1_DP	P4[29] - General purpose digital Input/Output pin.	Input/Output
		USB_D+1 - USB port 1 bidirectional D+ line.	Input/Output
13	USB1H_PWRD	P4[26] -General purpose digital Input/Output pin.	Input/Output
		BLS0 - LOW active Byte Lane select signal 0.	Output
14	USB1H_OVC	P4[24] - General purpose digital Input/Output pin.	Input/Output
15	USB1H_PPWR	P0[19] - General purpose digital Input/Output pin.	Input/Output
		CAP1[1] - Capture input for Timer 1, channel 1	Input
		USB_PPWR1 - Port Power enable signal for USB port 1.	Output
16	P0.9_I2STX_SDA_MOSI1_MAT2.3	P0[9] -General purpose digital Input/Output pin.	Input/Output
		I2STX_SDA - I2S transmit data. It is driven by the transmitter and read by the receiver. Corresponds to the signal SD in the I2S-bus specification.	Input/Output
		MAT2[3] - Match output for Timer 2, channel 3	Output
		MOSI1 - Master Out Slave In for SSP1.	Input/Output
17	P0.8_I2STX_WS_MISO1_MAT 2.2	P0[8] -General purpose digital Input/Output pin.	Input/Output
		I2STX_WS - I2S Transmit word select. It is driven by the master and received by the slave. Corresponds to the signal WS in the I2S-bus specification.	Input/Output
		MAT2[2] - Match output for Timer 2, channel 2	Output

		MISO1 - Master In Slave Out for SSP1.	Input/Output
18	P0.7_I2STX_CLK_SCK1_MAT 2.1	P0[7] – General purpose digital Input/Output pin.	Input/Output
		I2STX_CLK - I2S transmit clock. It is driven by the master and received by the slave. Corresponds to the signal SCK in the I2S-bus specification.	Input/Output
		MAT2[1] - Match output for Timer 2, channel 1	Output
		SCK1 - Serial Clock for SSP1.	Input/Output
19	P0.6_I2SRX_SDA_SSEL1_MAT2.0	P0[6] - General purpose digital Input/Output pin	Input/Output
		I2SRX_SDA - I2S Receive data. It is driven by the transmitter and read by the receiver. Corresponds to the signal SD in the I2S-bus specification.	Input/Output
		SSEL1 - Slave Select for SSP1.	Input/Output
		MAT2[0] - Match output for Timer 2, channel 0	Output
20	P0.5_I2SRX_WS_TD2_CAP2.1	P0[5] - General purpose digital Input/Output pin.	Input/Output
		I2SRX_WS - I2S Receive word select. It is driven by the master and received by the slave. Corresponds to the signal WS in the I2S-bus specification.	Input/Output
		TD2 - CAN2 transmitter output.	Output
		CAP2[1] - Capture input for Timer 2, channel 1	Input
21	P0.4_I2SRX_CLK_RD2_CAP2.0	P0[4] - General purpose digital Input/Output pin.	Input/Output
		I2SRX_CLK - I2S Receive clock. It is driven by the master and received by the slave. Corresponds to the signal SCK in the I2S-bus specification.	Input/Output
		RD2 - CAN2 receiver input	Input
		CAP2[0] - Capture input for Timer 2, channel 0	Input
22	Ground (GND)		Power
23	RESET_INn	External reset input: A LOW on this pin resets the device, causing I/O ports and peripherals to take on their default states, and processor execution to begin at address 0. TTL with hysteresis, 5 V tolerant	Input
24	RESET_OUTn	RSTOUT - This is a 3.3 V pin. LOW on this pin indicates LPC1788 being in Reset state	Output
25	P0.26_AD03_AOUT_RXD3	P0[26] General purpose digital Input/Output pin.	Input
		AD0[3] - A/D converter 0, input 3.	Output
		AOUT - D/A converter output.	Input
		RXD3 - Receiver input for UART3	Input/Output
26	P1.31_SCK1_AD0.5	P1[31] – General purpose digital Input/Output pin.	Input/Output
		SCK1 - Serial Clock for SSP1.	Input/Output
		AD0[5] - A/D converter 0, input 5	Input
27	P1.17_ENET_MDIO	P1[17] - General purpose digital Input/Output pin.	Input/Output
		ENET_MDIO - Ethernet MIIM data input and Output	Input/Output
28	P1.16_ENET_MDC	P1[16] - General purpose digital Input/Output pin.	Input/Output
		ENET_MDC - Ethernet MIIM clock	Output

29	Ground (GND)		Power
30	P1.15_ENET_REFCLK	P1[15] – General purpose digital Input/Output pin.	Input/Output
		ENET_REF_CLK/ENET_RX_CLK – Ethernet Reference Clock (RMII interface)/ Ethernet Receive Clock (MII interface)	Input
31	P1.14_ENET_RX_ER	P1[14] –General purpose digital Input/Output pin.	Input/Output
		ENET_RX_ER - Ethernet receive error (RMII/MII interface)	Input
32	3p3 volts	3.3 volts	Power
33	P1.10_ENET_RXD1	P1[10] – General purpose digital Input/Output pin.	Input/Output
		ENET_RXD1 - Ethernet receive data 1 (RMII/MII interface)	Input
34	P1.9_ENET_RXD0	P1[9] - General purpose digital Input/Output pin.	Input/Output
		ENET_RXD0 - Ethernet receive data 0 (RMII/MII interface)	Input
35	P1.8_ENET_CRSDV	P1[8] - General purpose digital Input/Output pin.	Input/Output
		ENET_CRSDV/ENET_CRSDV – Ethernet Carrier Sense/Data Valid (RMII interface)/ Ethernet Carrier Sense (MII interface)	Input
36	P1.4_ENET_TXEN	P1[4] - General purpose digital Input/Output pin.	Input/Output
		ENET_TX_EN - Ethernet transmit data enable (RMII/MII interface)	Output
37	P1.1_ENET_TXD1	P1[1] - General purpose digital Input/Output pin.	Input/Output
		ENET_TXD1 - Ethernet transmit data 1 (RMII/MII interface)	Output
38	P1.0_ENET_TXD0	P1[0] - General purpose Digital Input/Output pin.	Input/Output
		ENET_TXD0 - Ethernet transmit data 0 (RMII/MII interface)	Output
39	Ground (GND)		Power
40	P2.10_EINT0_NMI	I/O - P2[10] - General purpose digital Input/Output pin. Note: LOW on this pin while RESET is LOW forces on-chip boot loader to take over control of the part after a reset.	Input/output
41	P0.3_RXD0	P0[3] - General purpose digital Input/Output pin.	Input/Output
		RXD0 - Receiver input for UART0	Input
42	P0.2_TXD0	P0[2] - General purpose digital Input/Output pin.	Input/Output
		TXD0 - Transmitter output for UART0	Output
43	USB_D ₊ 2	P0[31] - General purpose digital Input/Output pin.	Input/Output
		USB_D ₊ 2 - USB port 2 bidirectional D ₊ line	Input/Output
44	USB_D ₋ 2	USB_D ₋ 2 - USB port 2 bidirectional D ₋ line	Input/Output
45	USB_D_VBUS	P1[30] - General purpose digital Input/Output pin.	Input/Output
		USB_PWRD2 - Power Status for USB port 2.	Input
		VBUS - Monitors the presence of USB bus power. Note: This signal must be HIGH for USB reset to occur. I - AD0[4] - A/D converter 0, input 4	Input

46	5volts (5VO)	5.0 Volts	Power
47	5volts (5VO)	5.0 Volts	Power
48	5volts (5VO)	5.0 Volts	Power
49	3p3 volts (3V3)	3.3 Volts	Power
50	3p3 volts (3V3)	3.3 Volts	Power

J5 Signal Details

Pin #	Pin Name	Pin Description	Input/output
1	Ground (GND)		Power
2	P5.4_TXD0_OE_MAT3.3_TXD4 (LPC1788 only)	P5[4] – General Purpose digital Input/Output	Input/Output
		TXD0_OE - UART0 Transmitter Output Enable	Output
		MAT3[3] – Match output for Timer 3, channel 3	Output
		TXD4 – UART4 Transmit data	Output
3	P5.3_RXD4_SCL0+ (LPC1788 only)	P5[3] – General Purpose digital Input/Output	Input/Output
		RXD4- UART4 receive data	Input
		SCL0+ - I2C Clock for FM+ Operation	Input/Output
4	P5.2_MAT3.2_SDA0+ (LPC1788 only)	P5[3] – General Purpose digital Input/Output	Input/Output
		MAT3[2] – Match output for Timer 3, channel 2	Output
		SDA0+ - I2C Data for FM+ Operation	Input/Output
5	P1.12_MCIDAT3_PCAP0.0	P1[12] – General Purpose digital Input/Output	Input/Output
		MCIDAT3 – Data line 3 for SD/MMC interface	Input/Output
		PCAP0[0]- Capture input for PWM0 channel 0	Input
6	P1.11_MCIDAT2_PWM0.6	P1[11] – General Purpose digital Input/Output	Input/Output
		MCIDAT2 – Data line 2 for SD/MMC interface	Input/Output
		PWM0[6]-Pulse Width Modulator 0, output 6	Output
7	P1.7_MCIDAT1_PWM0.5	P1[7] – General Purpose digital Input/Output	Input/Output
		MCIDAT1 – Data line 1 for SD/MMC interface	Input/Output
		PWM0[5]-Pulse Width Modulator 0, output 5	Output
8	P1.6_MCIDAT0_PWM0.4	P1[6] – General Purpose digital Input/Output	Input/Output
		MCIDAT1 – Data line 1 for SD/MMC interface	Input/Output
		PWM0[4]-Pulse Width Modulator 0, output 4	Output
9	P1.5_MCIPWR_PWM0.3	P1[5] – General Purpose digital Input/Output	Input/Output
		MCIPWR – Power Supply Enable for external SD/MMC Power Supply	Output
		PWM0[3]-Pulse Width Modulator 0, output 3	Output
10	P1.3_MCICMD-PWM0.2	P1[3] – General Purpose digital Input/Output	Input/Output
		MCICMD – Command line for SD/MMC interface	Input/Output
		PWM0[2]-Pulse Width Modulator 0, output 2	Output
11	P0.1_TD1_RXD3_RXD0	P0[1] – General Purpose digital Input/Output	Input/Output
		TD1 – Can1 transmitter output	Output
		RXD3 – Receiver input for UART3	Input
		RXD0 – Alternate UART0 receive data	Input
12	P0.0_RD1_TXD3_TXD0	P0[0] – General Purpose digital Input/Output	Input/Output
		RD1 – Can1 receive input	Input
		TXD3- Transmitter output for UART3	Output
		TXD0 – alternate UART0 transmit data	Output
13	5volts(5VO)	5.0 Volts	Power

14	Ground (GND)		Power
15	P0.13_USB2_UPLD_AD0.7	P0[13] – General Purpose digital Input/Output	Input/Output
		UPLD- USB port 2 Good Link indicator	Output
		AD0[7]- A/D converter0, input 7	Input
16	P0.12_USBPPWR2_AD0.6	P0[12] – General Purpose digital Input/Output	Input/Output
		AD0[6]- A/D converter0, input 6	Input
17	P0.25_AD0.2_TXD3	P0[25] – General Purpose digital Input/Output	Input/Output
		AD0[2]- A/D converter0, input 2	Input
		TXD3 – Transmitter output for UART3	Output
18	TP_RL_Y2_P0.24_AD0.1	TP_RL_Y2 – Touch panel interface right side horizontal [Not Typically Supported]	
		P0[24] - General Purpose digital Input/Output	Input/Output
		AD0[1] – A/D converter0, input 1	Input
19	TP_RL_X1_P0.23_AD0.0	TP_RL_X1 – Touch Panel left side horizontal [Not Typically Supported]	
		P0[23] - General Purpose digital Input/Output	Input/Output
		AD0[0] – A/D converter0, input 0	Input
20	Ground (GND)		Power

Expansion Connector Cable Details

The maximum length for the expansion connector cables is as follows:

General Purpose IO, TTL, Serial, etc = 6” recommended maximum, 8” absolute maximum

Ethernet, high-speed IO, etc = 3” recommended maximum, 4” absolute maximum

The following table provides example part numbers for the expansion cables:

Description	Mfg	Mfg PN	Digi-Key Pn
3” 20-pin 0.5mm	Molex	21020-0209	WM10226-ND
6” 20-pin 0.5mm	Molex	21020-0215	WM10218-ND
3” 50-pin 0.5mm	Molex	21020-7650	WM10231-ND
6” 50-pin 0.5mm	Molex	21020-0548	WM10223-ND

Note: These lengths are only recommendations. The actual lengths utilized will be dependent on the expansion board circuitry, layouts and general environment of the application. It is up to the customer to test and validate the functional operation and use of the expansion connectors.

15. Mechanical Details

The following illustrations show the mechanical details of the uEZGUI-1788-70WVT PCB

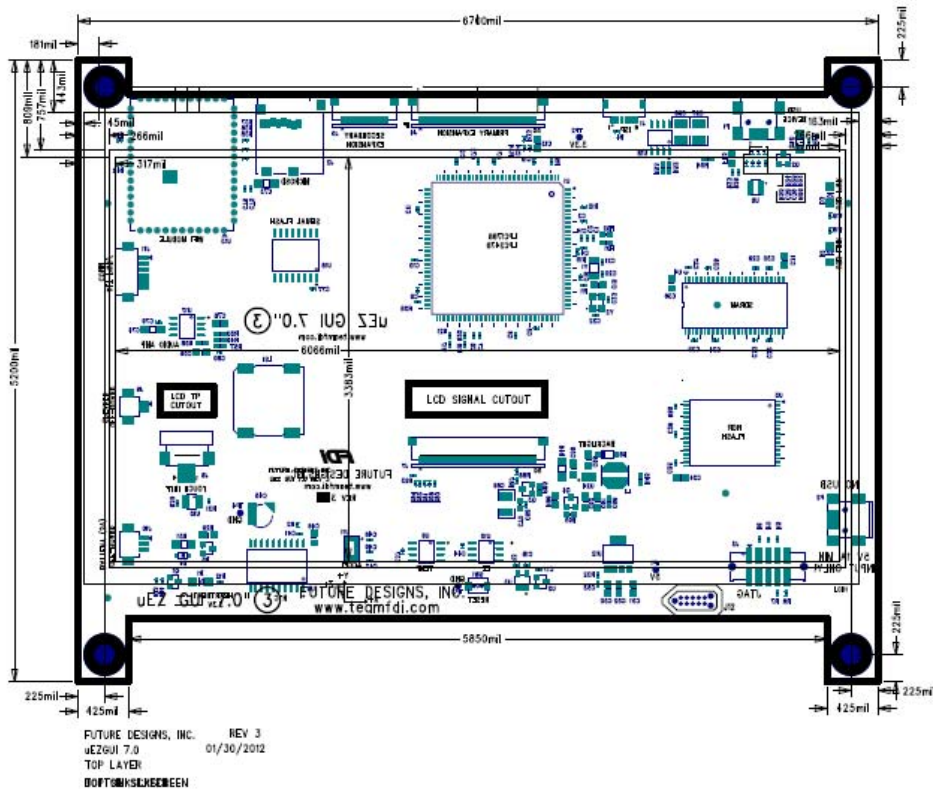

Figure 6 –Mechanical Layout (Component View)

ESD Warning

The uEZGUI-1788-70WVT kit is shipped in a protective anti-static package. The kit must not be subjected to high electrostatic potentials. Damage may occur to the boards that will not be covered under warranty. General practice for working with static sensitive devices should be followed when working with the kit.

16. Power Requirements

Power is supplied via a USB cable and power supply provided in the kit. The following typical power requirements were measured at room temperature with LPC1788 at 120MHz operating clock rate:

Voltage	Booted at the uEZ Demo Screen	Observed Max
5.0V	604mA	610mA

17. Useful links

- Segger Mini-JTAG Debugger
 - <http://www.segger.com/cms/jlink-software.html>
- Rowley Crossworks IDE download for 30-day evaluation
 - <http://www.rowley.co.uk/>
- uEZ software quick start guide
 - <http://www.teamfdi.com/uez/files/MA00015%20uEZ%20Software%20Quickstart%20Guide.pdf>

18. Schematics

Please see FDI the website at <http://www.teamfdi.com/> for support documentation.

19. Temperature Range

uEZGUI-1788-70WVT board w/o LCD: -40°C to +85°C

uEZGUI-1788-70WVT with LCD: -20°C to +70°C