

DETAILS

Product Number	CN12708_LENINA-W
Family	Lenina
Type	RefPack
Color	metal
Diameter	74 mm
Height	46,3 mm
Style	round
Optic Material	
Holder Material	
Fastening	screw
Status	production ready
ROHS Compliant	Yes
Date Updated	31/10/2016

OPTICAL PROPERTIES

LED	Viewing Angle	Light Beam	Efficiency	cd/lm	Connector
CLL04x/CLU04x	59 deg	Wide	84 %	1.000	-
CLU730/731	49 deg	Wide	93 %	1.200	-
LUXEON CoB 1216	58 deg	Wide	90 %	1.000	-
CXM-22	58 deg	Wide	92 %	1.100	LEDiL: LEDiL
COB D Series LES 22 mm	59 deg	Wide	91 %	1.000	-
ZC25/40	60 deg	Wide	86 %	0.900	-



Relative intensity of CN12708_LENINA-W

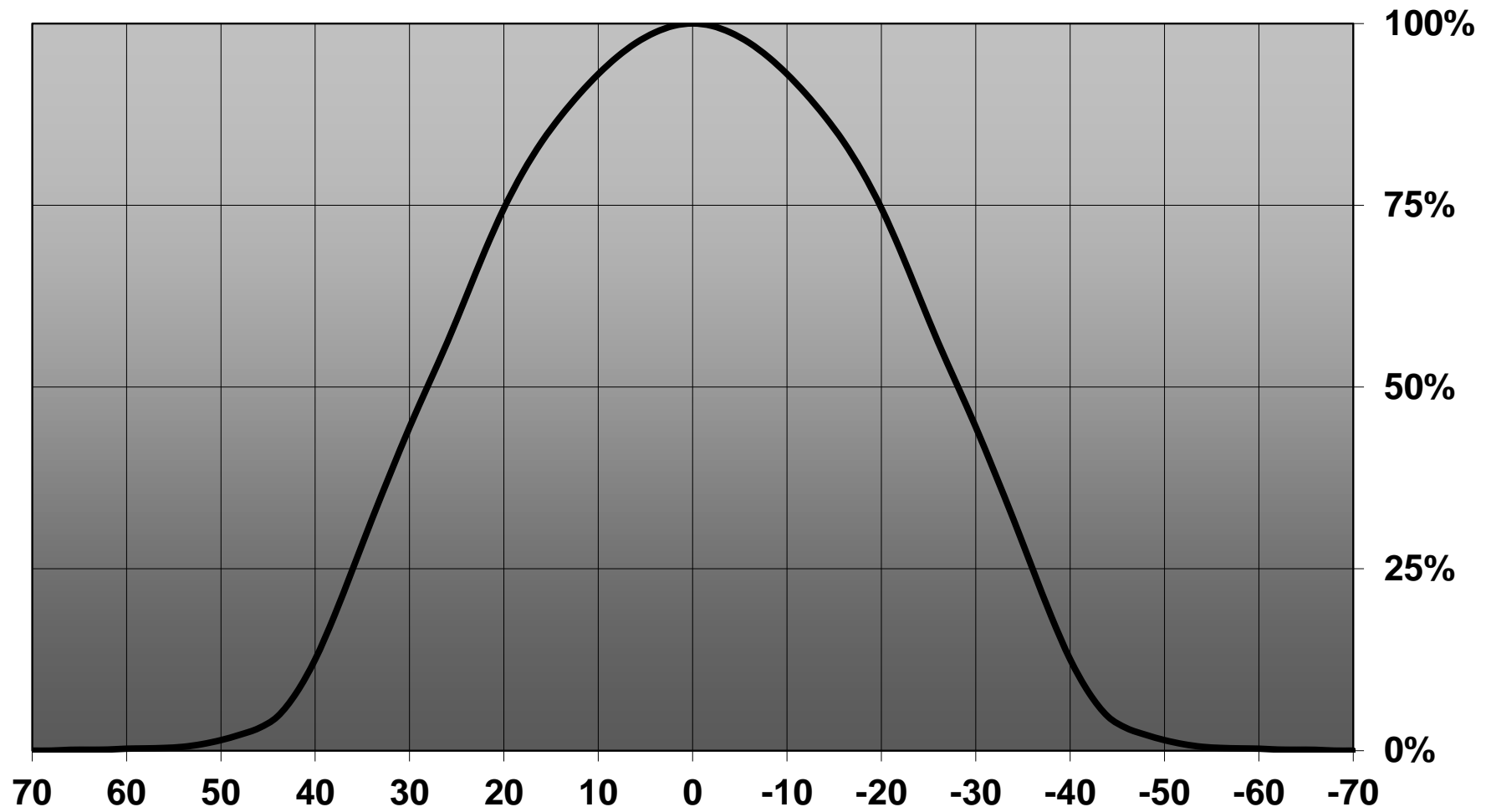

Relative intensity of CN12708_LENINA-W_(CXM-22)

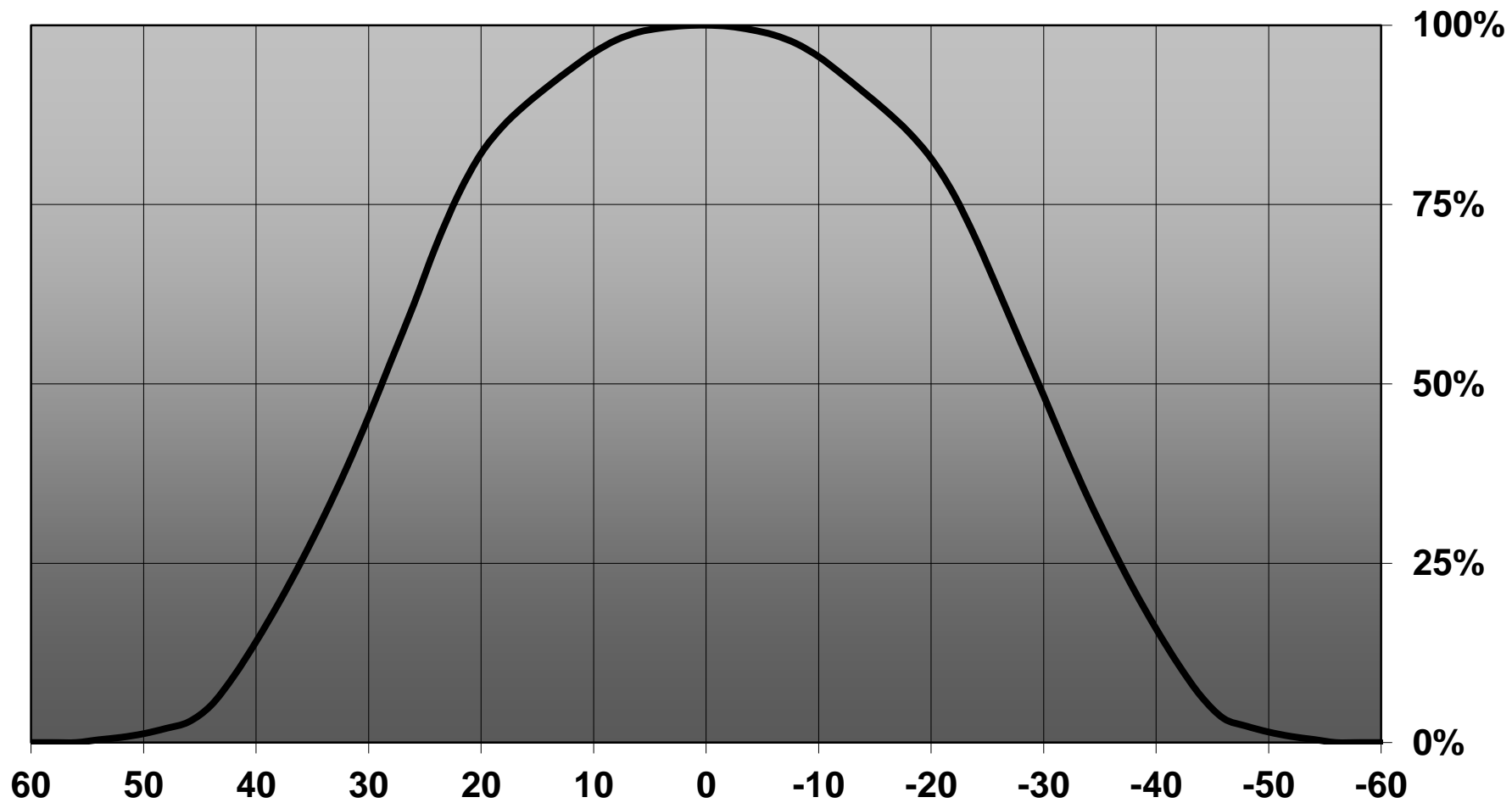

— 1: 0-180

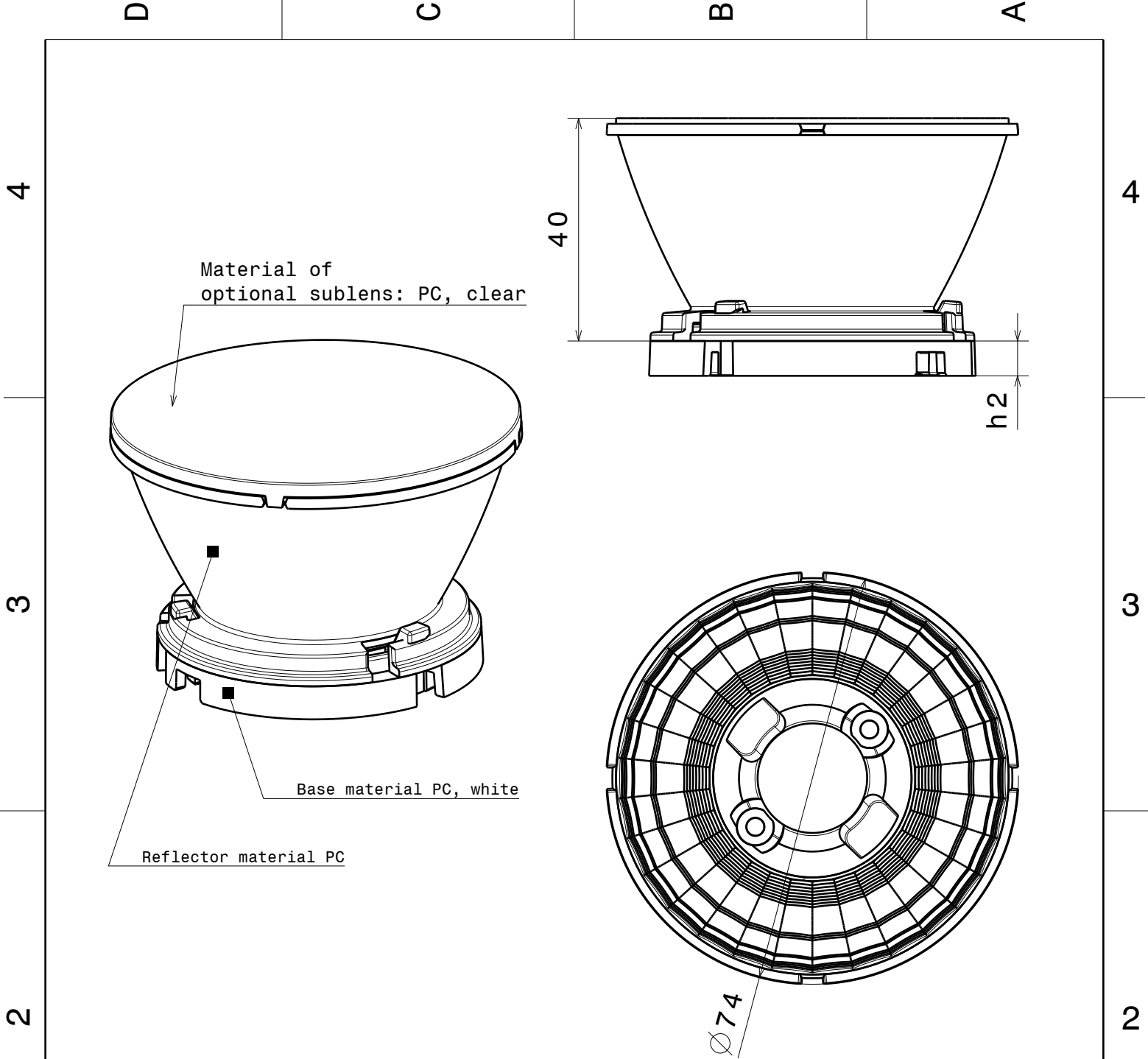

NOTE:

Using optional sublens, add 2.1mm to the system height

Dimension 'h2' varies from 4.5mm to 7mm depending on the LED specific base part

This drawing is our property. It can't be reproduced or communicated without our written agreement.



Ledil Oy
Salorankatu 10
FIN-24240 SALO
Finland

DRAWING TITLE

Datasheet Lenina series

DRAWN BY ks		DATE 23.04.2014		SIZE A4		DRAWING NUMBER --		REV 1	
CHECKED BY		DATE						SHEET 1 / 1	
DESIGNED BY pl		DATE 08.03.2012		SCALE 1 : 1		WEIGHT (g)			

D

A

Luminaire: Ledil Oy CN12708_LENINA-W (Citizen CLL040 1044lm @ 250mA) Efficiency=84%
Lamps: 1 x Citizen CLL040 1044lm @ 250mA

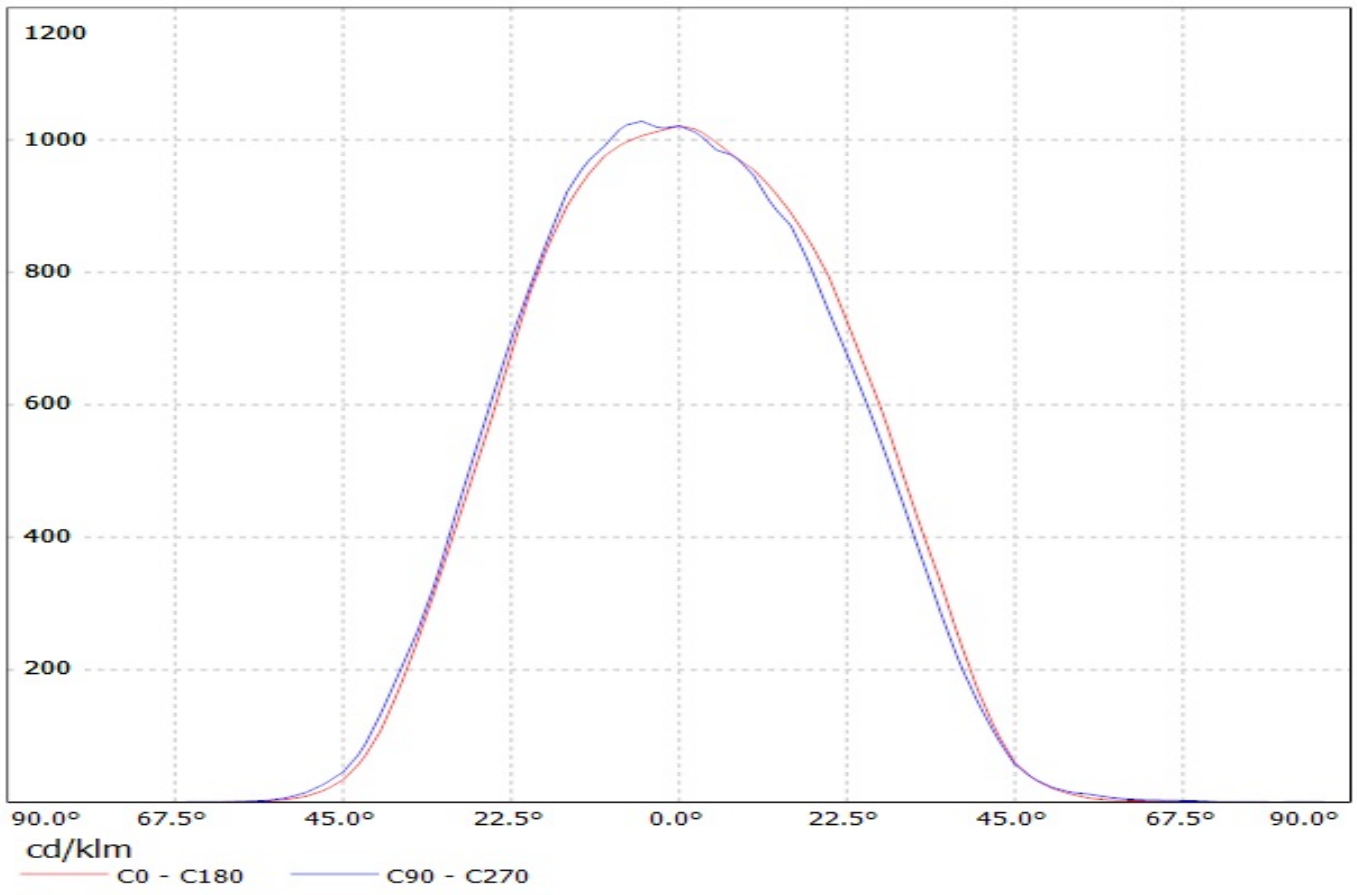

Luminaire: Ledil CN12708_LENINA-W_(CLU730)

Lamps: 1 x CITIZEN_CLU730_(C12692_LENA-STD-BASE-CLL040)_1247.17lm@250mA_P=8.5W_I=0.25A

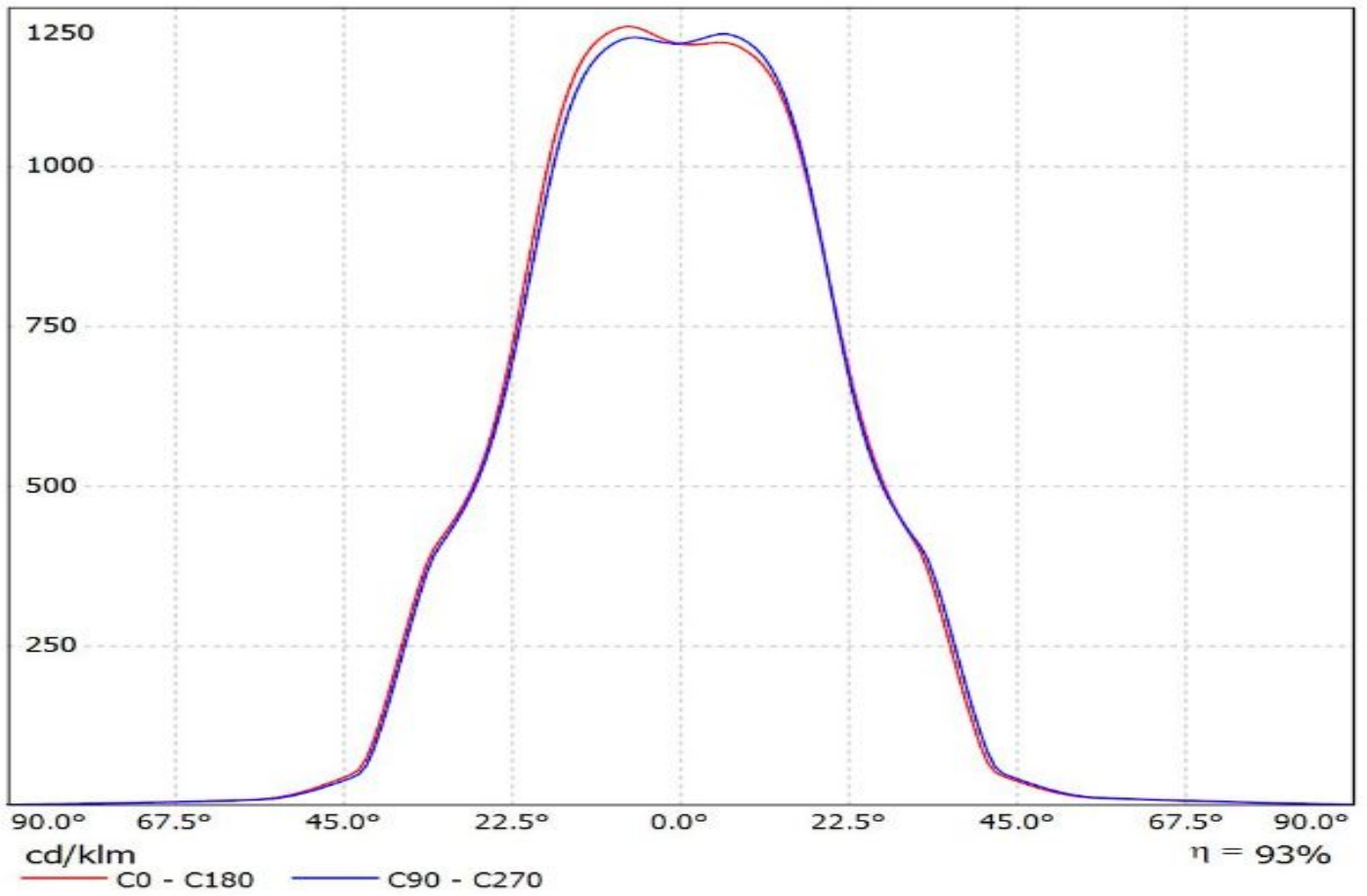

Ledil CN12708_LENINA-W_(CoB_1216) / LDC (Linear)

Luminaire: Ledil CN12708_LENINA-W_(CoB_1216)

Lamps: 1 x Luxeon_CoB_1216_(L2C2-40801216E2300)_1399.08lm@250mA_P=8.00375W_I=0.25A

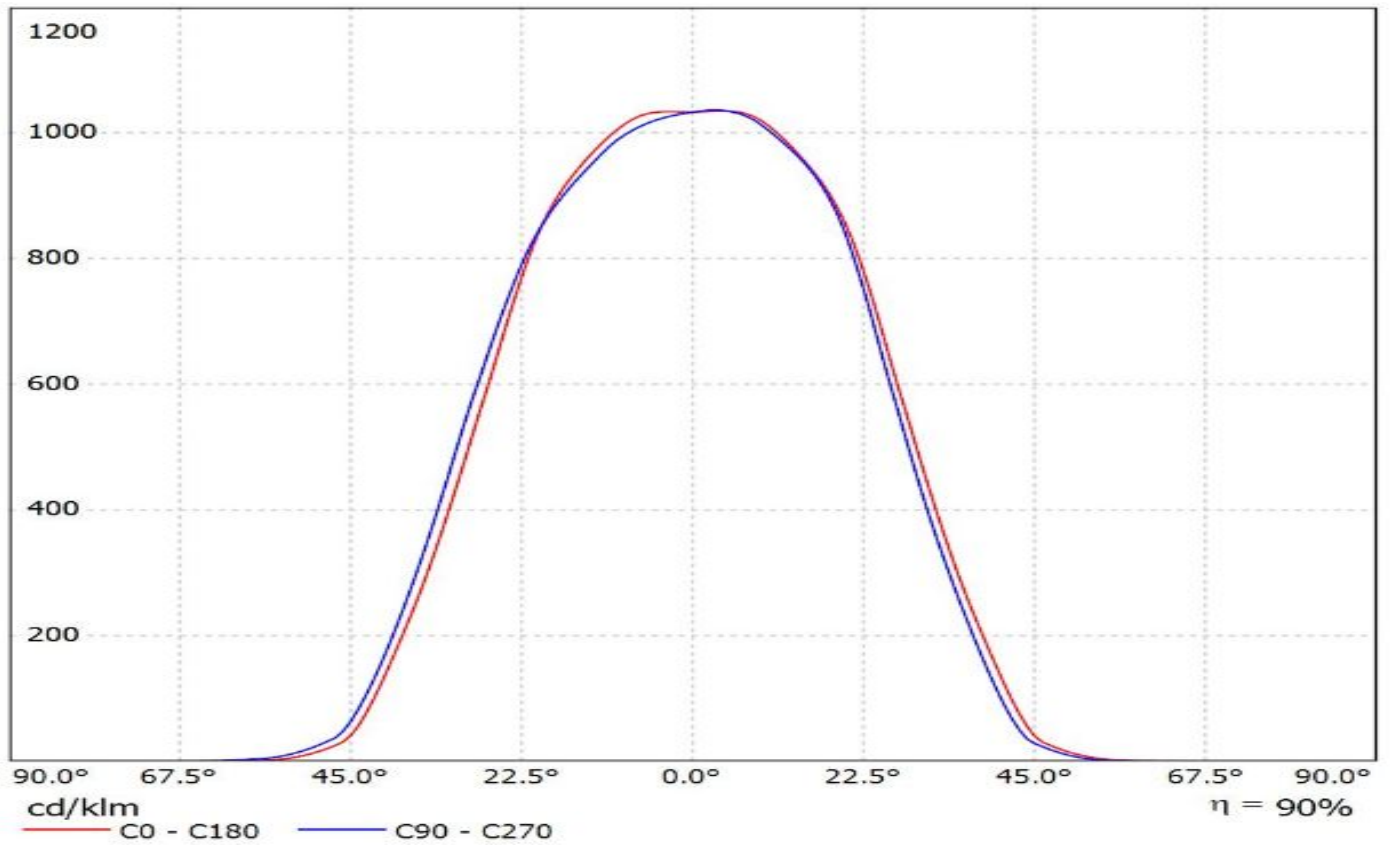

Luminaire: Ledil CN12708_LENINA-W_(COB_D_LES_22mm)

Lamps: 1 x Samsung_COB_D_LES_22mm_(SPHWHAHDNK25YZT3D1)+C12692_1511.79lm@250mA_CCT=4000K_P=8.0675W_I=0.250A

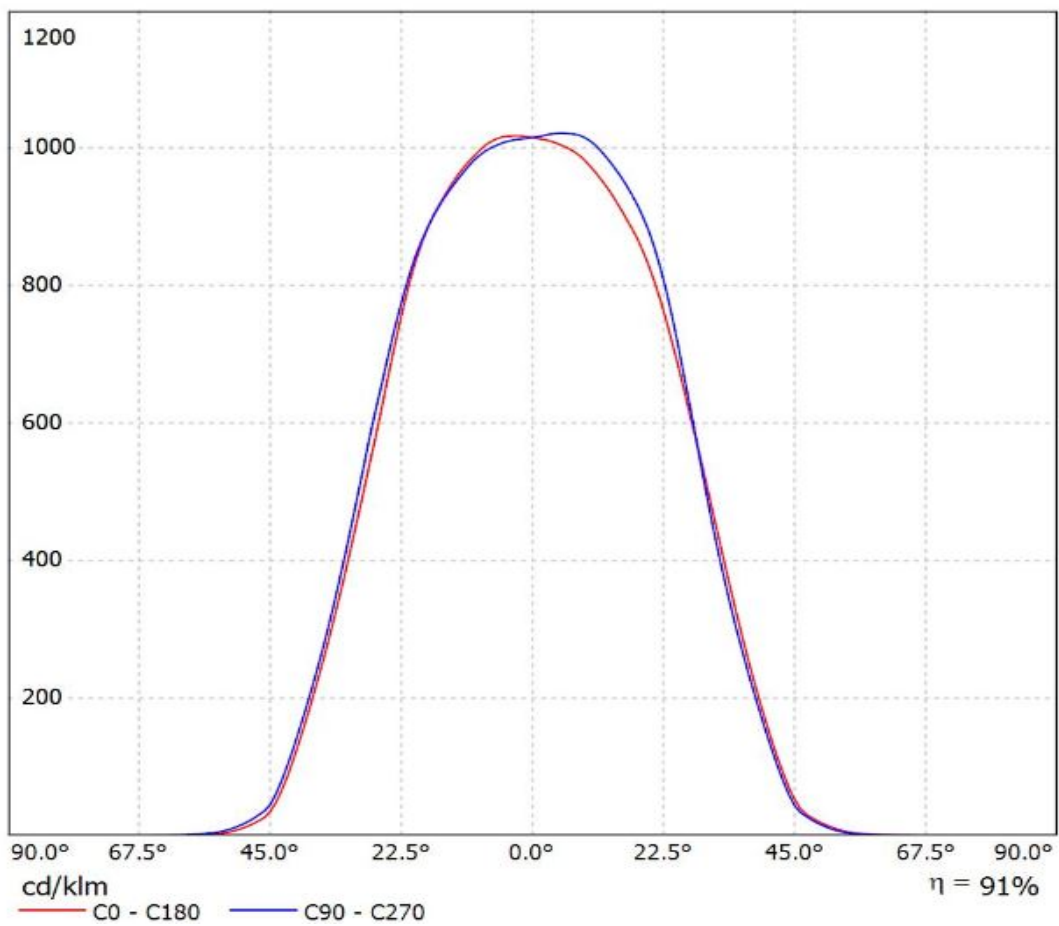

LEDiL Oy CN12708_LENINA-W_(ZC-40) Eff. 86,4% / LDC (Linear)

Luminaire: LEDiL Oy CN12708_LENINA-W_(ZC-40) Eff. 86,4%
Lamps: 1 x SEOUL_ZC-40 (1233.37lm@250mA)

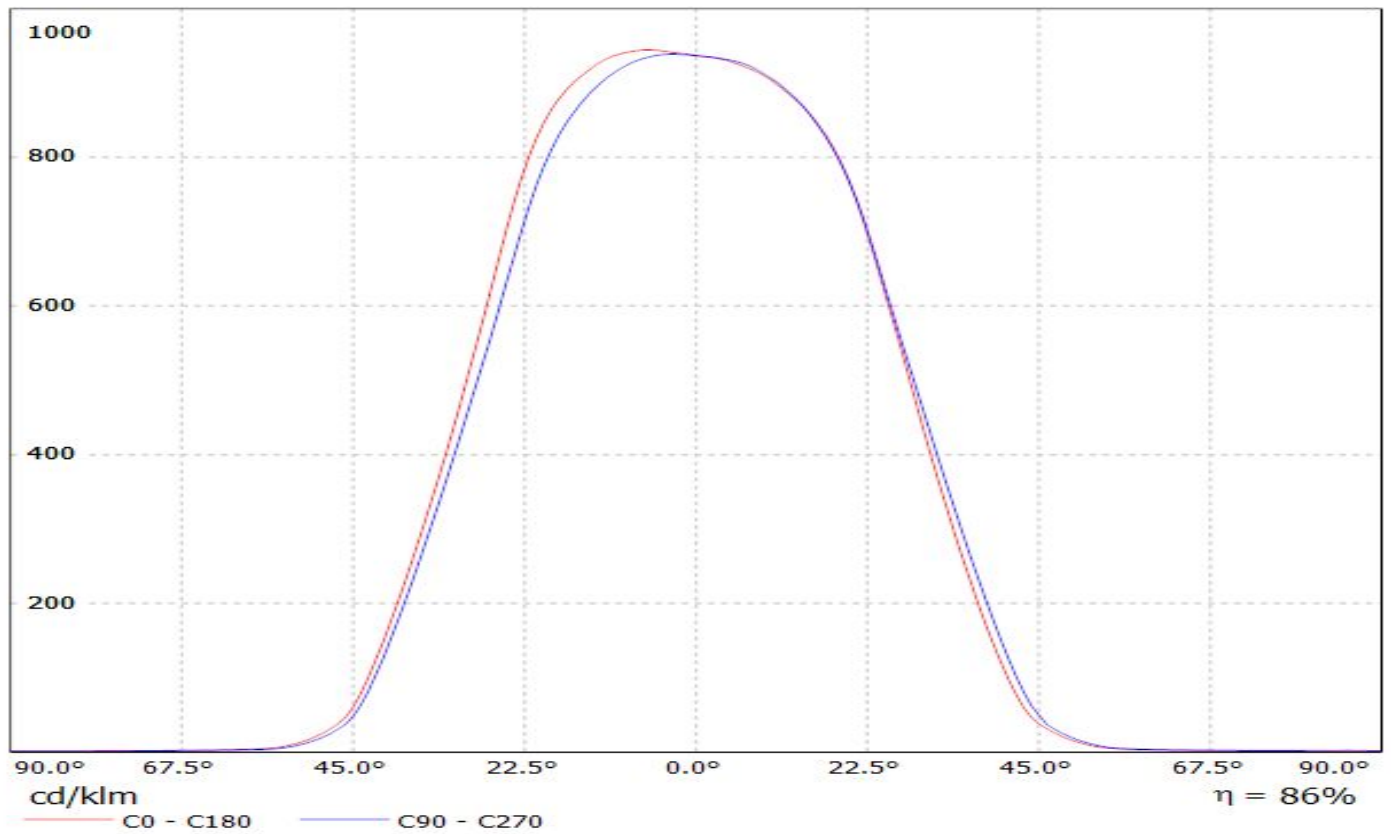

Luminaire: Ledil Oy CN12708_LENINA-W (Citizen CLL040 1044lm @ 250mA) Efficiency=84%
Lamps: 1 x Citizen CLL040 1044lm @ 250mA

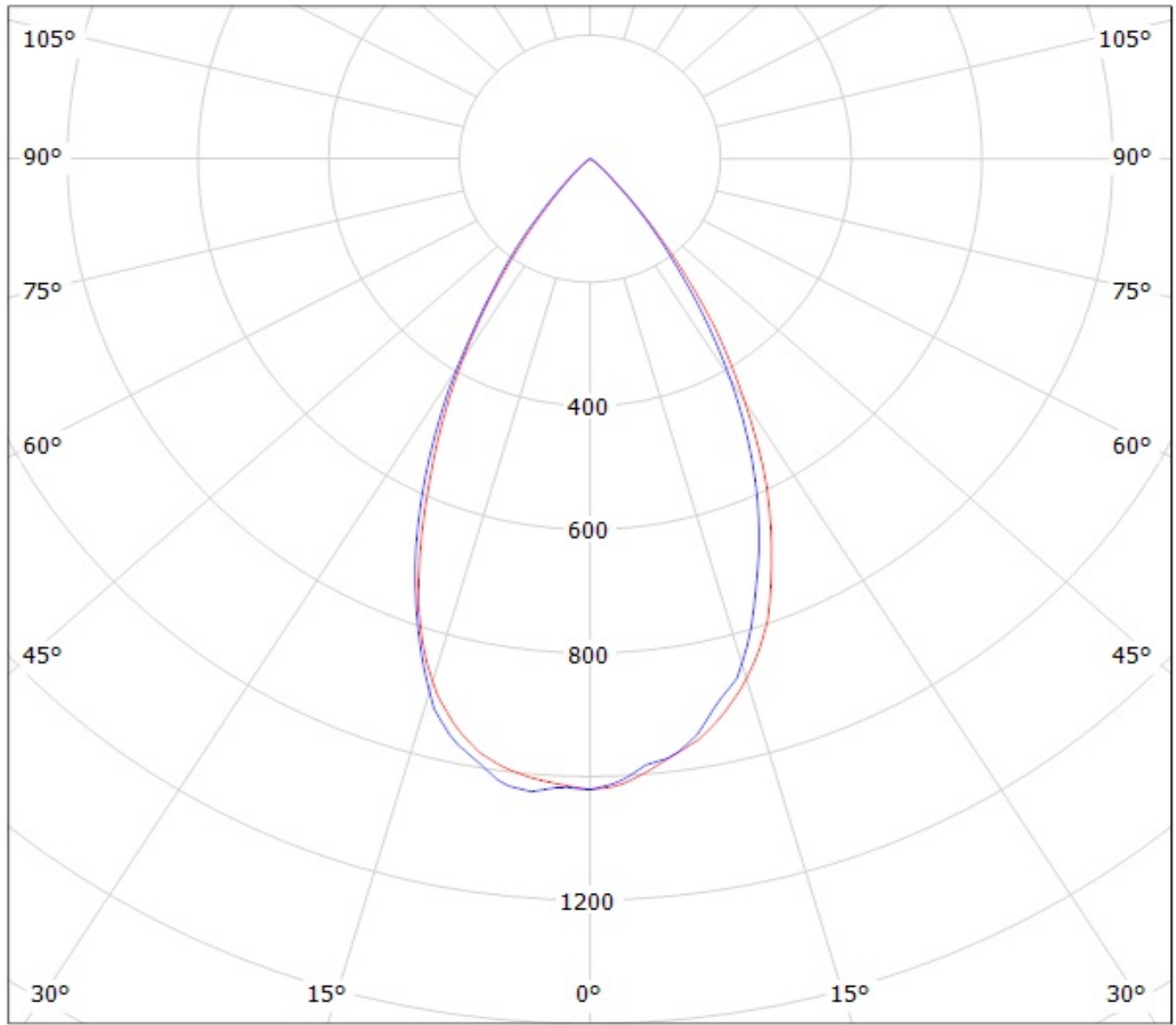

cd/klm

— C0 - C180 — C90 - C270

Luminaire: Ledil CN12708_LENINA-W_(CLU730)

Lamps: 1 x CITIZEN_CLU730_(C12692_LENA-STD-BASE-CLL040)_1247.17lm@250mA_P=8.5W_I=0.25A

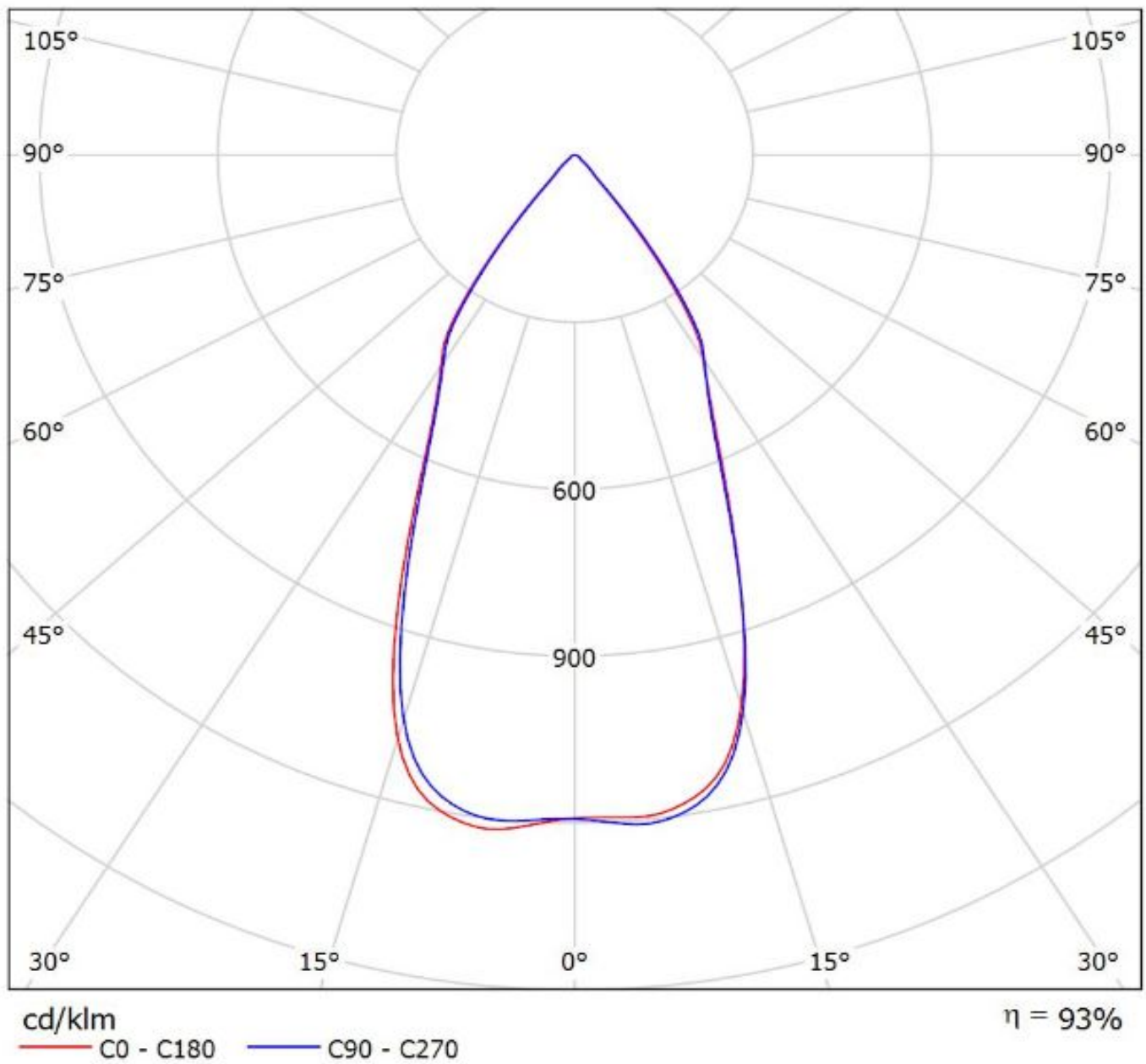

Ledil CN12708_LENINA-W_(CoB_1216) / LDC (Polar)

Luminaire: Ledil CN12708_LENINA-W_(CoB_1216)

Lamps: 1 x Luxeon_CoB_1216_(L2C2-40801216E2300)_1399.08lm@250mA_P=8.00375W_I=0.25A

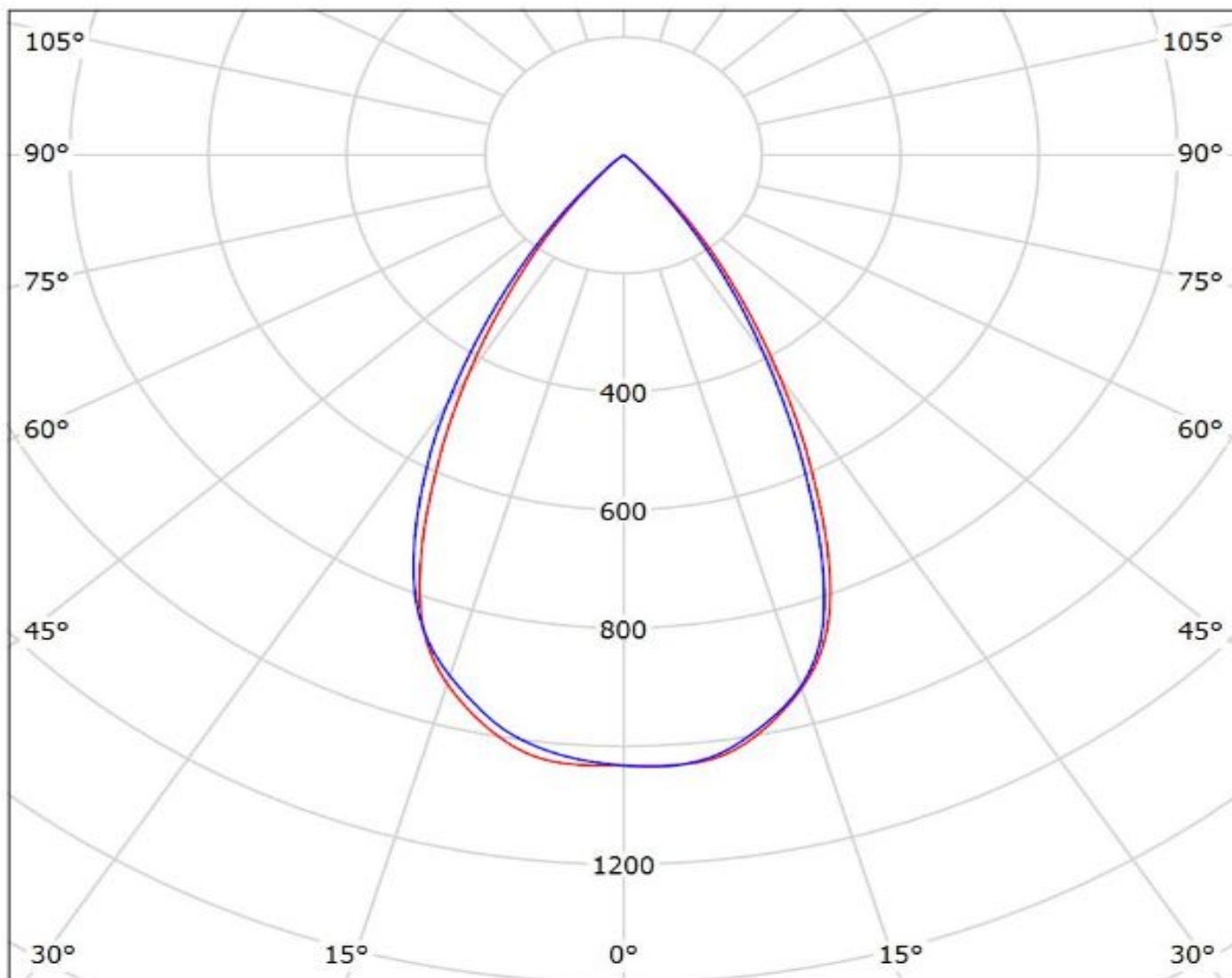

cd/klm

— C0 - C180

— C90 - C270

$\eta = 90\%$

Luminaire: Ledil CN12708_LENINA-W_(COB_D_LES_22mm)

Lamps: 1 x Samsung_COB_D_LES_22mm_(SPHWHAHDNK25YZT3D1)+C12692_1511.79lm@250mA_CCT=4000K_P=8.0675W_I=0.250A

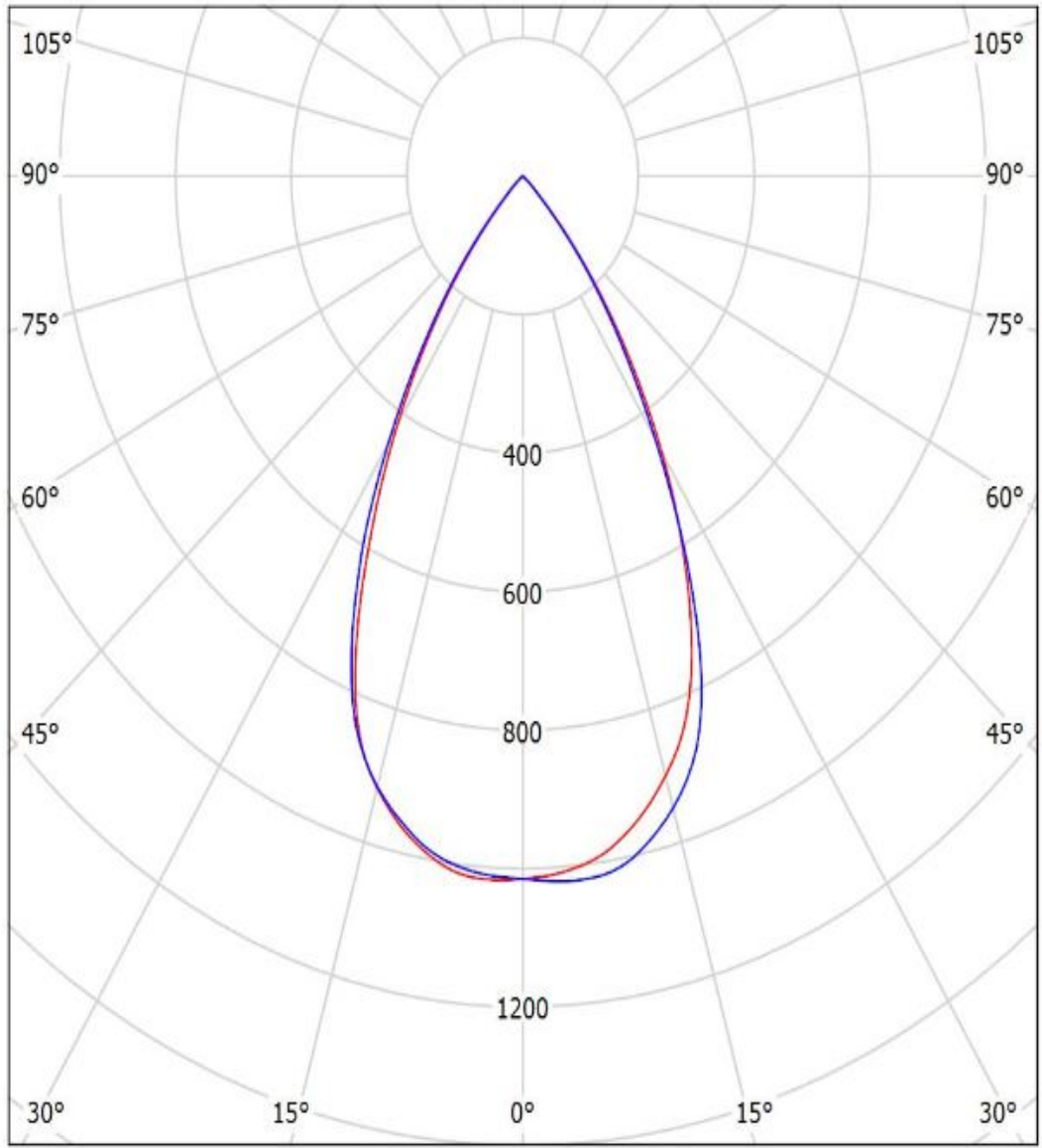

cd/klm

— C0 - C180 — C90 - C270

$\eta = 91\%$

LEDiL Oy CN12708_LENINA-W_(ZC-40) Eff. 86,4% / LDC (Polar)

Luminaire: LEDiL Oy CN12708_LENINA-W_(ZC-40) Eff. 86,4%

Lamps: 1 x SEOUL_ZC-40 (1233.37lm@250mA)

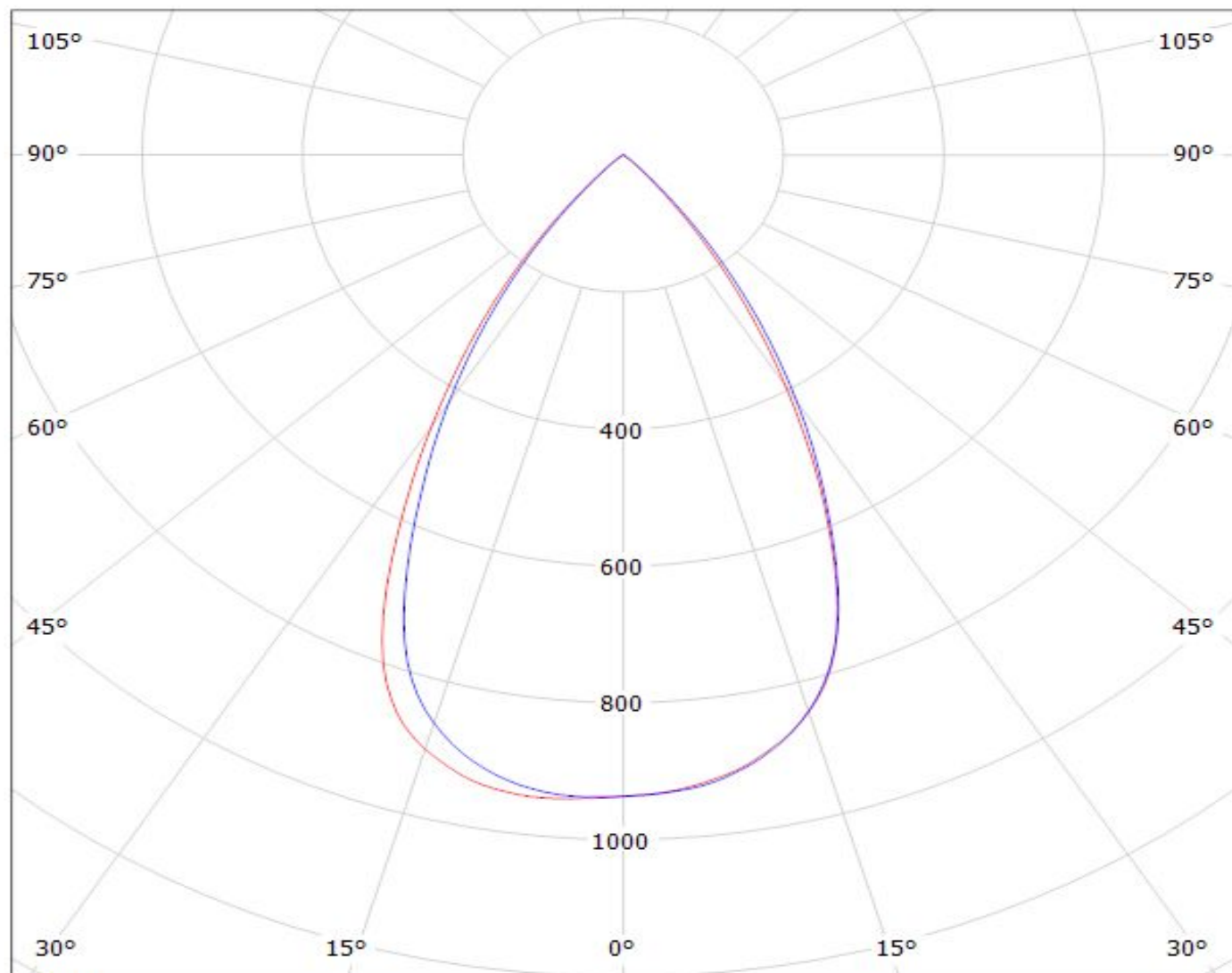

cd/klm

— C0 - C180

— C90 - C270

$\eta = 86\%$

NOTE: The typical divergence will be changed by different color, chip size and chip position tolerance. The typical total divergence is the full angle measured where the luminous intensity is half of the peak value.

GENERAL INFORMATION

- Product series especially designed & optimized for series of LEDs.
- Special care taken to make light distribution as uniform as possible.

Note! Due to use of high power COB's with this product, special attention to proper thermal design is highly recommended. LEDiL has no liability for direct, indirect or consecutive damages arising from the LEDiL products being used outside of the recommended temperature range.